

MSI-3650 MSI-6000

Options User Guide

*Quality Industrial
Weighing
and Force
Measurement
Equipment*

**ONLINE PRODUCT
WARRANTY REGISTRATION**

Click here to activate your
MSI Product Warranty today.

www.msiscales.com

*Measurement
Systems
International*

TABLE OF CONTENTS

INTRODUCTION 4

FUNCTION 4

ELECTRICAL CONFORMANCE 4

CABLING 5

 Table 1: Recommended Cable Configurations 5

 Table 2: MSI RS-232 Cable Installation Procedure 6

 RS-232 Cable Installation Procedure Comm Port 1 6

 RS-232/RS-485 Cable Installation Procedure

 Comm Port 2 8

DATA CONFIGURATION 9

 Data String Buffers 9

 Data Format 9

OPERATION 9

COMPORT MENU (SETUP-PRINT) 10

TEST COMM PORT 13

PRINTER FORMATTING 14

 Data Entry Procedure 14

 Character Set 14

 Printer Formatting Session Example 18

EDITING THE PRINT STRING 21

GENERAL TEXT/CONTROL CHARACTER ENTRY ... 22

PRINTER CONTROL “@” COMMANDS 23

REAL TIME CLOCK/CALENDAR 33

TIMEDATE SETUP MENU

 (IN MAIN SETUP MENU) 33

COMPUTER OPERATION 35

MSI-6000/3650 RELAY OUTPUT OPTION 41

INTRODUCTION 41

FUNCTION 41

ELECTRICAL SPECIFICATIONS 41

RELAY CABLING 41

CABLE INSTALLATION PROCEDURE 42

RELAY APPLICATIONS 42

LOGIC OUTPUT (SETPOINT 8) 45

TEST SETPOINT RELAYS 46

 Figure 10: Setpoint Relays Wiring Diagram 47

ASCII TABLE 48

NOTES 49

WARRANTY 50

INTRODUCTION

This option adds a single RS-232 serial input/output and a Real Time Clock/Calendar. The serial output is intended for interfacing printers, data loggers, scoreboards, and computers to the Check-Weigh 6000 / 3650 Meter. The real-time clock allows the user to time and/or date stamp any data obtained from the 6000 / 3650.

The 6000 / 3650 under menu control will print control characters for easy interfacing to any label printer. An initialize string combined with start string, product labels, user programmable data, weight data, and end strings, provides complete control over printed data.

A second Comm Port option is available (must be ordered separately). The second Comm Port can be RS-485, RS-232, or a Fiber-Optic output. The second Comm Port is programmed independently from Comm Port1 and can be used for a different function than Comm Port1. For example, a printer could be connected to Comm Port1, and a computer connected to Comm Port2.

Many scales and weigh meters suspend weighing operation while printing and will not function until a print job is completed. The MSI-6000 / 3650 RS-232 option uses advanced DMA (direct memory access) techniques for transmitting the print strings. This prevents long print jobs from interfering with scale operation.

FUNCTION

The RS-232 output is used in conjunction with the PRINT key to output weight and total data to a printer or can be used for 2-way communications with a computer. In addition there are several automatic print modes including print on ACCEPT, when there is a weight change, or when a setpoint is reached.

ELECTRICAL CONFORMANCE

COMM PORT 1

The electrical characteristics of the serial output is configured to conform to the EIA Standard EIA-232-D (downward compatible with RS-232-C). Comm Port 1 is configured as DCE. Cable connections include RXD (input), TXD (output), Ground, CTS (input), RTS (output), and Shield Ground (also known as Frame Ground). CTS/RTS handshaking is optional and the lines do not need to be connected.

COMM PORT 2 (2nd Comm Port Option only)

Comm Port 2 can be configured in three ways:

- 1) *RS-232* - In the RS-232 mode, the electrical characteristics of the serial output are configured to conform to the EIA Standard EIA-232-D (downward compatible with RS-232-C). The port is configured as DCE. Cable connections include RXD (input), TXD (output), Signal Ground, and RTS (Output). The RTS output is passive and indicates to the DTE port that the cable connection is made. There is no shield ground connection due to the isolated port. Tie the shield ground to the chassis of the DTE side. Cut any shield ground off and insulate it from the MSI-6000 chassis.
- 2) *RS-485* - The RS-485 mode is a half-duplex serial communications channel capable of driving up to 4000 feet of cable. In addition, 32 RS-485 devices can be daisy-chained together providing networking capabilities. In accordance with RS-485 standards the cabling should be terminated at the extreme ends of the cable (not at each node) with a 120Ω resistor in series with a 0.1μF ceramic capacitor. Cable Connections are I/O+, I/O-, and signal ground. Serial data is both transmitted and received on the same lines (half duplex).
- 3) *Fiber-Optic Output (Option)* - The Fiber-Optic Output provides an output capable of driving 3000 feet of plastic fiber optic cable. This is an output only and intended for driving printers or transmitting data to a computer when no computer control or handshaking is necessary.

CABLING

The Comm Port 1 RS-232 connections are made into TB3 found on the circuit board internal to the MSI-6000 / 3650. Due to washdown requirements, no cable is supplied with the option. Cables with an outside diameter of .187" to .300" (5mm to 7.5mm) are sealable with the watertight fitting. Cables should have shielded twisted pair connections. In the table below, twisted pairs are represented by A, B, and C.

Comm Port Mode	Hand Shaking	Min. # of Cond's	W 1A	W 2A	W 1B	W 2B	W 1C	W 2C
TALK Only	None	2 + Shield	TXD	GND	-	-	-	-
LISTEN Only	None	2 + Shield	RXD	GND	-	-	-	-
TALK Only	CTS/RTS	4 + Shield	TXD	GND	CTS	RTS	-	-
LISTEN Only	CTS/RTS	4 + Shield	RXD	GND	-	-	-	-
DUPLEX	None or SW	4 + Shield	TXD	GND	RXD	GND	-	-
DUPLEX	CTS/RTS	6 + Shield	TXD	GND	RXD	GND	CTS	RTS
Port 2 RS-465	None or SW	2 + Shield	I/O+	I/O-	-	-	-	-

Table 1: Recommended Cable Configurations

MSI Supplied RS-232 Cable Color Code

For units supplied with the RS-232 cable already installed, use table 2.

Signal Name	Function	Wire Color	Table 1 Ref
TXD	Data from Scale (output)	Blue/White Stripe	1A
SGND	Signal Ground, (TXD return)	White/Blue Stripe	2A
RXD	Data to Scale (input)	Green/White Stripe	1B
SGND	Signal Ground, (RXD return)	White/Green Stripe	2B
CTS	Handshake to Scale (input)	Orange/White Stripe	1C
RTS	Handshake from Scale (output)	White/Orange Stripe	2C
Frame GND	Connect the Shield	Drain Wire	-

Table 2: MSI RS-232 Cable Description

Note: Hook both SGND lines to the signal ground pin on the connector. For output only connections, it is not necessary to use the Green/White pair. See Table 1.

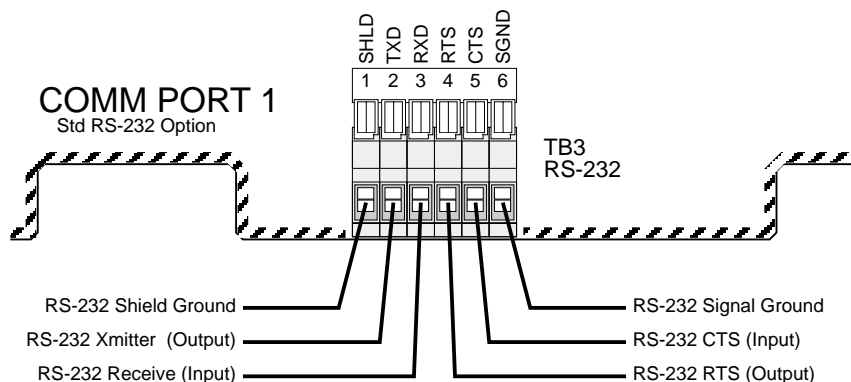

RS-232 Cable Installation Procedure, Comm Port 1:

- 1) MSI-6000 - Remove the 10 screws holding the rear panel on.
MSI-3650 - Remove the 10 screws holding the front panel on.
- 2) Strip the outer insulation 1.5" (40mm) from the cable. Peel back the foil shield (if any) being careful not to nick the conductors. Cut off the foil shield leaving the drain wire intact. Strip 3/16" (5mm) from each conductor and tin the wires. Slip a 1 5/16" (33mm) piece of sleeving over the drain wire and tin the end of the drain wire. It is also wise to shrink a short piece of heat shrink tubing over the end of the outer jacket to further insulate the shield.
- 3) Loosen the center watertight feedthrough and remove the white plug. Feed the RS-232 cable through the center watertight feedthrough.
- 4) The terminal block is either of two types. The first type is a standard screw terminal block. The second type uses a push lever. Insert the wires as

shown in the following diagram. Screw down each wire with a small screwdriver or if your unit is installed with the push type, insert a small flat bladed screwdriver in the white lever and push down to insert the wire. Use only the wires necessary for your application per table 1. Be sure to terminate the shield wire in position 1 (Shield Ground aka Frame ground). In the Duplex w/ CTS/RTS mode where there are two signal grounds, connect both signal grounds to pin 6. After all the pins are connected, lightly wiggle and tug on each wire to ensure that they are securely attached. Retighten or reposition the wires as necessary.

- 5) Replace the back panel being careful to seat the gasket evenly around the lip of the cabinet. Screw down the 10 backpanel screws in a crisscross pattern to seat the gasket evenly.
- 6) Tighten the watertight feedthrough around the outer insulation to ensure the water seal.

RS-232 Cable Installation Procedure, Comm Port 2 (2nd Comm Port option installed):

- 1) MSI-6000 - Remove the 10 screws holding the rear panel on.
MSI-3650 - Remove the 10 screws holding the front panel on.
- 2) Strip the outer insulation 1.5" (40mm) from the cable. Peel back the foil shield (if any) being careful not to nick the conductors. Cut off the foil shield and the drain wire. Strip 3/16" (5mm) from each conductor and tin the wires. It is wise to shrink a short piece of heat shrink tubing over the end of the outer jacket to further insulate the shield.
- 3) Loosen the center watertight feedthrough and remove the white plug. Feed the RS-232 cable through the center watertight feedthrough. If the center watertight feedthrough is occupied, install the 2nd Comm Port cable through the watertight feedthrough on the rear panel.
- 4) The terminal block is either of two types. The first type is a standard screw terminal block. The second type uses a push lever. Insert the wires as shown in the following diagram. Screw down each wire with a small screwdriver or if your unit is installed with the push type, insert a small flat bladed screwdriver in the white lever and push down to insert the wire. Use only the wires necessary for your application per table 1. Note that RTS is a passive output in Comm Port 2 and that there is no CTS. After all the pins are connected, lightly wiggle and tug on each wire to ensure that they are securely attached. Retighten or reposition the wires as necessary.
- 5) Replace the back panel being careful to seat the gasket evenly around the lip of the cabinet. Screw down the 10 backpanel screws in a crisscross pattern to seat the gasket evenly.
- 6) Tighten the watertight feedthrough around the outer insulation to ensure the water seal.

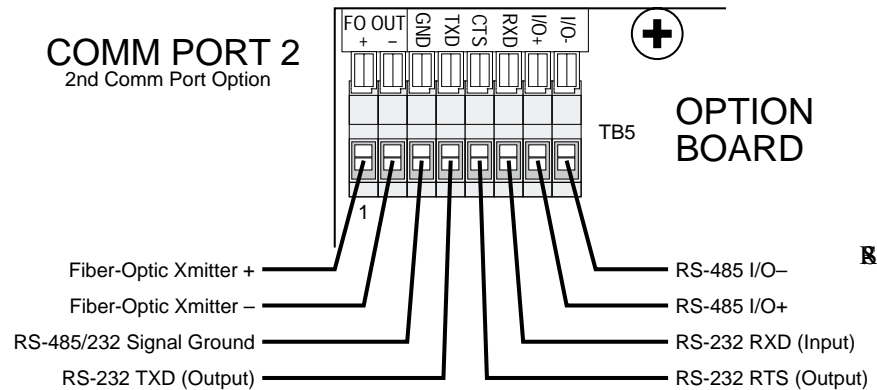

485 Cable Installation Procedure, Comm Port 2 (2nd Comm Port option installed):

- 1) MSI-6000 - Remove the 10 screws holding the rear panel on.
MSI-3650 - Remove the 10 screws holding the front panel on.
- 2) Strip the outer insulation 1.5" (40mm) from the cable. Peel back the foil shield (if any) being careful not to nick the conductors. Cut off the foil shield leaving the drain wire intact. Strip 3/16" (5mm) from each conductor and tin the wires. Slip a 1 5/16" (33mm) piece of sleeving over the drain wire and tin the end of the drain wire. It is wise to shrink a short piece of heat shrink tubing over the end of the outer jacket to further insulate the shield.
- 3) Loosen the center watertight feedthrough and remove the white plug. Feed the RS-232 cable through the center watertight feedthrough. If the center watertight feedthrough is occupied, install the 2nd Comm Port cable through the watertight feedthrough on the rear panel.
- 4) The terminal block (TB5) is either of two types. The first type is a standard screw terminal block. The second type uses a push lever. Insert the wires as shown in the following diagram. Screw down each wire with a small screwdriver or if your unit is installed with the push type, insert a small flat bladed screwdriver in the white lever and push down to insert the wire. Connect wire 1A to I/O+ and wire 2A to I/O-. Connect the shield to pin 3 ground After all the pins are connected, lightly wiggle and tug on each wire to ensure that they are securely attached. Retighten or reposition the wires as necessary.
- 5) Replace the back panel being careful to seat the gasket evenly around the lip of the cabinet. Screw down the 10 backpanel screws in a crisscross pattern to seat the gasket evenly.
- 6) Tighten the watertight feedthrough around the outer insulation to ensure the water seal.

DATA CONFIGURATION

The MSI-6000 / 3650 serial port options are configured with the “COMPORT” Menu. Standard data configuration is:

Parameter	Default	Menu Choices
Baud Rate	9600	300, 500, 1200, 2400, 4800, 9600, 19200, 38400
Data Bits	8	7 or 8
Parity	None	None, Even, Odd
Start Bits	1	1 (can't be changed)
Stop Bits	1	1 or 2

Data String Buffers

Data Strings are defined by the user. The length of the formatting strings are limited per the following table. However, since 3 or 4 character commands can cause an output of up to 99 characters in length, the following numbers do not represent the maximum size of the data output.

String	Comm Port 1 Max. Characters	Comm Port 2 Max. Characters
Data	175	175
Start Line	4	4
End Line	4	4
Wait Character	1	1

Data Format

Each transmitted reading consists of a number of programmable character strings. Data is completely user programmable and can include formatting characters and text in addition to all weight parameters. The End-of-Line string is used for Carriage Return or other end-of-line control characters. These are easily entered through the Comm Port menu or downloaded through a computer.

OPERATION

The MSI-6000 / 3650 serial port can be used in 10 modes:

- 1) Front Panel Print Key:
This is a print on command mode which works when the print button on the front panel is pushed. The Print key is active in all modes unless disabled by computer control. The “MOTN DET” menu determines if printing is allowed or disallowed when the weight is in motion and/or not stable.
- 2) Computer Control:
The computer can control and receive data from the MSI-6000 / 3650

through the use of simple ASCII commands. These commands can be sent through the use of a data communications terminal, or a custom computer program. The “MOTN DET” menu determines if printing is allowed or disallowed when the weight is in motion and/or not stable.

- 3) Print on Accept (MSI-6000 only):
When the accept range is reached and motion ceases, one transmission of data will occur. Once transmitted, the scale must return to within 1% of Net or Gross zero to re-enable the transmission. Interval has no effect in this mode.
- 4,5 & 6) Print on Set-Point:
Setpoint 1, Setpoint 2, or Setpoint 1&2 can be configured to cause a data print. Once transmitted, the setpoint must go off then on again to transmit again. Print on a Setpoint can also be configured to not print until two setpoints are true. This configuration allows printing when the weight is outside two limits or when the weight is inside two limits (windowed). The “MOTN DET” menu determines if printing is allowed or disallowed when the weight is in motion and/or not stable.
- 7) Print On Change:
Every time the weight changes 1 full display count or more, one transmission of data will occur. The “MOTN DET” menu determines if printing is allowed or disallowed when the weight is in motion and/or not stable. Interval has no effect in this mode.
- 8) Print on Load Change:
When the load weight exceeds 2% of capacity and motion ceases, one transmission of data will occur. Once transmitted, the scale must return to within 1% of Net or Gross zero to re-enable the transmission. Interval has no effect in this mode.
- 9) Print Continuous or on Intervals:
The Data String can be transmitted continuously for driving scoreboards. The “MOTN DET” menu determines if printing is allowed or disallowed when the weight is in motion and/or not stable.
- 10) Print on CTS:
By toggling the CTS line from space to mark, the print string will be transmitted. If the interval is set, the string will continue to print as long as CTS is asserted.

COMPORT MENU (SETUP-PRINT)

Function:

Communications port setup and Data Formatting.

Operation:

Push SETUP followed immediately by PRINT.

Top Menu	Category	Sub-Menu	Selections
COMPORT 1 FORMAT		DATA	Defaults to print gross weight, tare weight and net weight on separate lines
		STRTLINE	Enter start of line characters (4 char. max.)
		END LINE	Enter end of line characters - defaults to LF (4 char. max.)
		WAIT CHR	Enter printer wait character (1 char. only)
MODE CONTROL		DUPLEX , OFF, TALK, LISTEN	
		PRINTKEY , CONTIN, ON CTS, ON SP1, ON SP2, SP1+SP2, ON CHNG, ON LOAD, ONACCEPT (MSI-6000 only), ON TOTAL	
MOTION INTERVAL		ENABLED , DISABLED	
		ONCE , ON	
	If "ON"	Enter 0-28800 seconds with 0 being the display update rate	
SETTINGS	BAUDRATE	STOPBITS	300, 600, 1200, 2400, 4800, 9600 , 19200
		DATBITS	1 BIT , 2 BIT
		PARITY	7 BIT, 8 BIT
		HANDSHAK	NONE , EVEN, ODD
			CTS/RTS, NONE , XON/XOFF
			<i>Same as COMPORT 1 except no CTS/RTS handshaking</i>
SCALE ID		Enter number from 1-255 (default = 1)	
COMTYPE2		RS-232, RS-485, F-OPTIC	

COMM PORT SETUP MENUS

FORMAT

The FORMAT menu is the heart of the communications system.

DATA: The “DATA” section is where all printing and formatting commands are entered. This is covered in depth in the “Printer Formatting” section.

STRTLINE: The “START LINE” string can be 0 to 4 characters long. It is intended for commonly used commands that usually precede printed lines. Typically ESC codes are used on some printers to enable or format the print string. The start of line string is usually referred to as the “SOL string”. The string defaults to empty.

END LINE: The “END-OF-LINE” string can be 0 to 4 characters long. Most commonly used for Carriage Return (CR) or Line Feed (LF), or CR/LF. The EOL string defaults to Line Feed.

WAIT CHR: The “WAIT CHARACTER”, if entered, will cause the print output to pause after each EOL string until the designated character is received by the port. To use the Wait Character mode, the Comm Port mode must be Duplex. Once the proper Wait Character has been received the 6000 / 3650 will output the next data string up to the next EOL string.

MODE

The MODE menu sets the communications mode for the port. Use “TALK” for

outputting data to a printer that uses hardware handshaking or no handshaking. Use “DUPLEX” for printers with software handshaking (XON / XOFF, etc.) or to talk and listen to a computer. Use “LISTEN” to only receive commands from a computer. Use “OFF” to disable the port (and save power on battery units).

CONTROL

The control menu designates the condition that causes the 6000 / 3650 to print. The Print key will always work unless specifically locked out. When the designated control is received by the scale, the print string specified in the “DATA” menu will be transmitted. If the “MOTION” parameter is enabled, the motion annunciator must be off or the scale will ignore the print command.

PRINTKEY: Pushing the front panel switch will cause 1 data transmission.

CONTIN: The data string will print continuously. The speed of the transmission is limited by the display update rate (usually 4 readings/s), by the baud rate specified, and the length of the Data Transmission. You can specify an interval transmission from 0 to 28800 seconds. See “INTERVAL” for details.

ON CTS: A transition on the CTS line from space to mark will cause 1 data transmission.

ON SP1: When Set-Point 1 is true, and motion ceases, 1 data transmission will occur. The setpoint must go false before another transmission is enabled.

ON SP2: When Set-Point 2 is true, and motion ceases, 1 data transmission will occur. The setpoint must go false before another transmission is enabled.

SP1+SP2: Both Set-Point 1 and 2 must be true to cause a data transmission. This provides a data transmission that will print when the weight is inside a weight window, or outside a weight window.

ON CHANG: When the weight changes by at least 1d and motion ceases, a new data transmission occurs.

ON LOAD: When the weight makes a transition from Net or Gross zero to a stable reading (must be above 2% of capacity), 1 data transmission will occur. The weight must return to below 1% of capacity relative to Net or Gross zero to re-enable the transmission. This prevents the same weightment from printing twice. Interval has no effect in this mode.

ONACCEPT (MSI-6000 only): When the weight is in the Accept range and motion ceases, 1 data transmission will occur.

ON TOTAL: Whenever a total is taken (either manual or automatic), 1 data transmission will occur.

MOTION

When enabled the scale will only print settled data, i.e. when the motion detection annunciator is off. In legal for trade systems, the MOTN DET menu item is not editable. Use DISABLED when it is necessary to send data out the comm port while the weight is in motion.

INTERVAL

Selecting "ONCE" means that after the trigger condition, a single transmission of data will occur. Selecting "ON" enables a timed transmission rate. A print interval can be entered from 0 to 28,800 seconds. Used in conjunction with the Continuous output mode, this can generate a time based data-logging system. An interval of 0 seconds means that the scale will output data at the highest rate possible (limited to 4 readings per second). Interval used with other control modes can be useful for control and monitoring purposes.

SCALE ID

This menu designates an ID number that is needed in multiple scale setups (usually hooked up with RS-485). A unique number per scale from 1 to 255 is programmed.

COM2TYPE (Comm Port 2 option installed)

This menu designates the operating mode of Comm Port 2. Comm Port 2 works as a RS-232, RS-485, or Fiber Optic output (units installed with fiber optic output option only).

TEST COMM PORT

The following test will verify port formats such as baud rate and stop bits, and will send out a listing of all the data formatting commands. The listing will aid in developing your print strings.

- 1) Remove the seal port on the left side of the MSI-6000/3650.
- 2) With your finger poised over the Print key, push the Calibrate enable switch inside the seal port followed *immediately* by the Print key.
- 3) The printer should start printing a listing of all the commands. If it does not, check the wiring, baud rate, data bits, stop bits, parity and handshaking to make sure that the MSI-6000/3650 and the printer are configured and wired correctly for each other.
- 4) When the listing is finished printing the scale returns to normal operation.

PRINTER FORMATTING

The RS-232 Option can format virtually any printer including complex bar-code label printers through the use of the built in printer formatting. To use this versatile feature, the user must input command codes and data in a specific manner. Each command code consists of a 2 letter mnemonic. Some command codes also require a numeric suffix.

A simple example of this structure is the default print data string: @W2@E@W4@E@W3,@E^{N_U}. The “@W2” command means to print the gross weight. The “@E” command means to print the end-of-line string. The @W4 command means to print the tare weight. The “@E” command means to print the end-of-line string. The “@W3” command means to print the net weight. The “@E” command means to print the end-of-line string. The command string must always be terminated by an ASCII null character (ASCII 0). We’ll indicate nulls with “^{N_U}”.

By combining the “@” commands with standard ASCII characters, control characters, etc., any data available from the scale, plus any additional text, can be printed in any order desired. Using formatting controls typical to modern bar-code printers is simply a matter of formatting the printer strings.

The MSI-6000 / 3650 character set is limited to upper case letters, numbers, and a few punctuation characters. To output other characters it is necessary to input them in numeric form.

General Data Entry Procedure:

- 1) To input a standard MSI-6000 / 3650 character, use the UP/DOWN keys to scroll through the available character set. When the desired character is displayed, push ENTER.
- 2) The cursor will move over for the next character. Continue entering characters until finished. Push ENTER twice to exit and save the data entry. Alternately push the POWER button to exit and save the data entry.

Hint: The standard character set always starts with a space. Pushing the Down key once will move directly to the “@” symbol allowing quick entry of the printer formatting codes. Continuing down goes directly to the numerics needed for the control code suffixes.

Character Set:

space ABCDEFGHIJKLMNOPQRSTUVWXYZ “\$%()*+ /<=>?); 976543210@ (repeat)







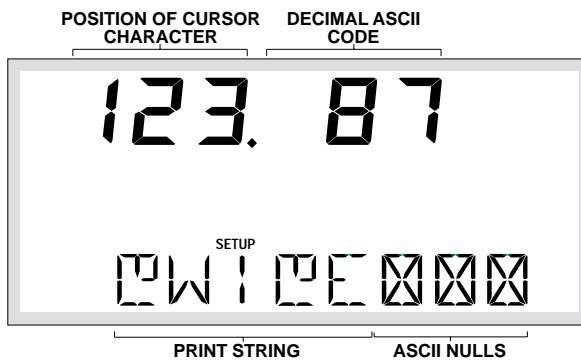

Any other character can be printed with the following procedure.

Data Entry Procedure - Alternate Characters and Control Characters:









- 1) Push the TARE key. This enables the ASCII numeric entry mode. A placeholder character indicates an ASCII character not included in the MSI-6000 / 3650 character set.
- 2) Use the UP/DOWN keys to scroll to the decimal number of the desired ASCII character. Refer to the ASCII table in Appendix A. The left digits on the LCD represents the character position. The right digits represent the ASCII decimal character number. When the desired character number is displayed, push ENTER.



MSI-6000 KEY FUNCTIONS during DATA ENTRY:

<p>POWER </p>	<p>Used as "SAVE and EXIT". Most useful when editing a long text string.</p>
<p>TARE SET </p>	<p>Enables the "ENTER ASCII" mode. Use this key to enter ASCII characters and control characters not included in the standard MSI-6000 character set.</p>
<p>ZERO </p>	<p>Used to insert characters within a string. Position the cursor over the character you wish to insert in front of, then push the zero key. The Zero key inputs an ASCII Null and therefore can also be used to terminate a print string.</p>
<p>TARGET  ENTER</p>	<p>Used to enter characters. If pushed twice on a Null character (ASCII 0) functions as "EXIT and SAVE". Also, if the cursor is positioned over a character that has already been entered, pushing the Enter key functions as "EXIT and SAVE".</p>
<p> </p>	<p>Used to scroll through the available character set or to scroll numbers for the ASCII entry mode.</p>
<p>USER </p>	<p>Left cursor. Use to move the text string left and to position the cursor over characters to be edited.</p>
<p>PRINT </p>	<p>Right cursor. Use to move the text string right and to position the cursor over characters to be edited.</p>
<p>UNITS  CLEAR</p>	<p>Clear. Will erase any character the cursor is positioned on and move the remaining characters to the left.</p>

MSI-3650 KEY FUNCTIONS during DATA ENTRY:

<p>POWER</p> 	<p>Used as "SAVE and EXIT". Most useful when editing a long text string.</p>
<p>TARE</p> 	<p>Enables the "ENTER ASCII" mode. Use this key to enter ASCII characters and control characters not included in the standard MSI-3650 character set.</p>
<p>TOTAL</p> 	<p>Used to insert characters within a string. Position the cursor over the character you wish to insert in front of, then push the zero key. The Zero key inputs an ASCII Null and therefore can also be used to terminate a print string.</p>
<p>USER</p> 	<p>Used to enter characters. If pushed twice on a Null character (ASCII 0) functions as "EXIT and SAVE". Also, if the cursor is positioned over a character that has already been entered, pushing the Enter key functions as "EXIT and SAVE".</p>
<p>SETUP</p>  <p>VIEW Σ</p> 	<p>Used to scroll through the available character set or to scroll numbers for the ASCII entry mode.</p>
<p>ZERO</p> 	<p>Left cursor. Use to move the text string right and to position the cursor over characters to be edited.</p>
<p>NET/GROSS</p> 	<p>Right cursor. Use to move the text string left and to position the cursor over characters to be edited.</p>
<p>TEST</p>  <p>CLEAR</p>	<p>Clear. Will erase any character the cursor is positioned on and move the remaining characters to the left.</p>

Example Printer Formatting Session

The following example will take you step by step through a formatting process. The end result of this example will produce a print out like this:

CHICKEN LEGS
4.500 lb NET 8/15/92

In this example we'll use control characters to both print in red and expand the characters for "Chicken Legs."











Note: control codes used in this example are unique to a specific printer (a Star Micronics DP8340) and are used for example only. The necessary string will be:

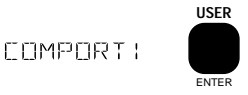

[27][14]
[20][27]
[0]
ⓧ4ⓧCHICKEN LEGSⓧⓧ5@E@W3@D2@Eⓧ
①②
③④⑤⑥⑦⑧⑨

- 1) The 27 is an ESC followed by a 4 which equals "Red Character Print instruction."
- 2) The 14 is an SO which turns on the Expanded character instruction.
- 3) The 20 is an DC4 which turns off the Expanded character instruction.
- 4) The 27 is an ESC followed by a 5 which turns off the Red Character Print instruction.
- 5) @E causes the end-of-line string to be sent.
- 6) @W3 causes the current Net weight to be printed. If the scale was in the NET mode, @W1 would have worked as well.
- 7) @D2 causes the current date to be printed in MM/DD/YY format.
- 8) @E causes the end-of-line string to be sent.
- 9) The 0 is a NULL which terminates the entire print string.

MSI-6000 Key Strokes

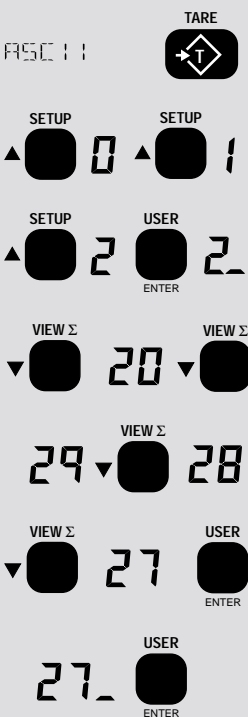
MSI-3650 Key Strokes

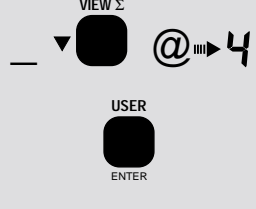
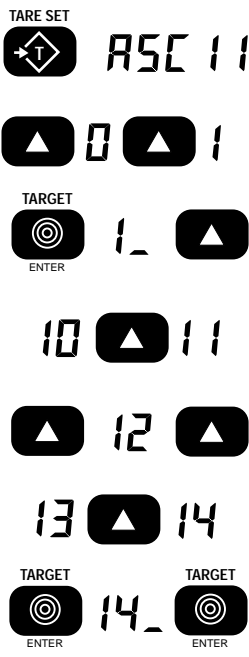
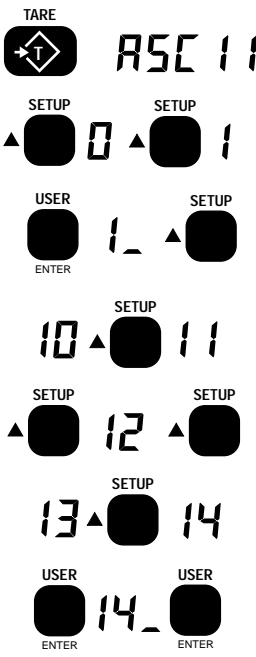
<p>1) Push SETUP followed immediately by the PRINT key.</p>		
<p>2) The message reads "COMPORT1". Push ENTER.</p>		
<p>3) The message reads "FORMAT". Push ENTER.</p>		
<p>4) The message reads "DATA". Push ENTER. The LCD changes into the formatting mode. Any previously stored printer DATA will appear on the screen. You can just write over the top of it.</p>		
<p>5) First we need to enter an ASCII ESC character. Referring to the ASCII chart (Appendix A) we find the ESC is decimal 27. We will use the ASCII entry mode to place a 27 in the string.</p> <p>Push TARE SET. The LCD message changes to "ASCII". The numeric digits indicate the decimal number of the ASCII character. Push the UP key to enter a new number. Push UP twice until a 2 appears. Push ENTER. Use the DOWN key to change the next number to a 7. Push ENTER. Push ENTER on the blank character to finish.</p> <p>The resultant string so far should look like this: </p> <p>The  character takes the place of the 27 we just entered. This can be verified by backspacing 1 space and noting the decimal display. It should read " 1. 27" meaning the first character is an ASCII 27.</p>		

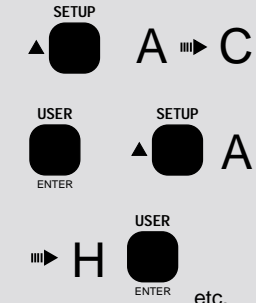
<p>6) Push the DOWN key and the letter “@” appears. Continue pushing the DOWN key until the number 4 appears. If you overshoot use the UP key to backstep. Once the blinking letter is at a “4”, push ENTER. Our string now is at “⊠4”.</p>		
<p>7) Using the step 5 procedure, enter an ASCII 14.</p>		
<p>8) Next enter the text “CHICKEN LEGS” through the use of the UP/ DOWN and ENTER keys. The resultant string so far should look like this:</p> <p>⊠4 ⊠ CHICKEN LEGS</p> <p>Finish out the remaining characters of our example in a like manner. The entire string must end with an ASCII null. If the final character is not followed by a null character “⊠” put one in. To force an ASCII null push the CLEAR key.</p>		
<p>Final Result: ⊠4⊠CHICKEN LEGS⊠5⊠@E@W3@D2@E⊠</p>		

EDITING THE PRINT STRING

MSI-6000

To change a character:

Use the USER (<) and PRINT (>) keys to move around in the print string. The flashing digit indicates the editable character. Once the character needing changing is flashing, use the UP or DOWN keys to change it. If you need to change it to a character not in the 6000 / 3650 character set, use the ASCII number entry procedure. Push ENTER twice to store the edited string.

To insert a character:

Use the USER (<) and PRINT (>) keys to move around in the print string. The flashing digit indicates the editable character. Insert a new character in front of the flashing digit by pushing the ZERO key. Next input the desired character with the UP/DOWN keys or use the ASCII number entry procedure. Push ENTER twice to store the edited string.

To delete a character:

Position the cursor (blinking character) over the character you wish to delete. Push CLEAR. The remaining characters move over 1 space. Push ENTER twice to store the edited string.

MSI-3650

To change a character:

Use the Zero (<) and Net/Gross (>) keys to move around in the print string. The flashing digit indicates the editable character. Once the character needing changing is flashing, use the UP or DOWN keys to change it. If you need to change it to a character not in the 3650 character set, use the ASCII number entry procedure. Push ENTER twice to store the edited string.

To insert a character:

Use the Zero (<) and Net/Gross (>) keys to move around in the print string. The flashing digit indicates the editable character. Insert a new character in front of the flashing digit by pushing the ZERO key. Next input the desired character with the UP/DOWN keys or use the ASCII number entry procedure. Push ENTER twice to store the edited string.

To delete a character:

Position the cursor (blinking character) over the character you wish to delete. Push CLEAR. The remaining characters move over 1 space. Push ENTER twice to store the edited string.

GENERAL TEXT/CONTROL CHARACTER ENTRY

Purpose

Text or control characters are simply entered into the printer data string. All ASCII characters from 0dec to 127dec can be entered with the exception of the “@” symbol which the 6000 / 3650 uses for its control characters (enter “@@” to print a single “@”). If 8 bit data transmission is enabled additional codes 128 to 255 can also be assigned. These upper numbers are often used for graphics characters on printers.

Input Data Form

With the exception of letters following the command “@” symbol, all characters are treated as printable text/controls. Terminate the string with a null character (ASCII 0). The MSI-6000 / 3650 represents characters that can't be displayed on the LCD with a “☒”. Null characters are represented with a “☒”. Use the ASCII table (Appendix A) to determine the decimal number equal to any desired character. See “Sample Printer Formatting Session” for more details.

Output Data Form

Output data form is entirely variable in length (limited by buffer size of 175 characters).

Example 1 - Text only:

The quick brown fox jumps over the lazy dog.

Example 2 - Text mixed with control characters (represented by “☒”) The following string prints “MSI 6000” in large red characters on a Star Micronics DP8340 Tape Printer.

Note: Numbers enclosed in brackets are the ASCII codes in decimal form as shown on the numeric digits during data entry.

[27] [14] [20][27] [0]
 ☒4☒MSI 6000☒☒5@E☒

The 27 is an ESC followed by a 4 which equals “Red Character Print instruction.”
 The 14 is an SO which turns on the Expanded character instruction.
 The 20 is an DC4 which turns off the Expanded character instruction.
 The 27 is an ESC followed by a 5 which turns off the Red Character Print instruction.
 The @E prints the end-of-line string (Optional).
 The 0 is a NULL which terminates the string.

PRINTER CONTROL “@” COMMANDS

The printer formatting “@” commands and their data configurations are as follows:

@B PRINT BLANK SPACES

Purpose:

Use the @B command to cause the output to send a series of spaces. Can be used to position data on a label without having to enter multiple spaces.

Input Data Form:

@Bxx where xx is any number from 01 to 99 which equals the number of spaces desired. Note: Exactly two digits must follow the “@B” command.

Output Data Form:

x spaces are output limited to 99. For more spaces use two @B commands in series.

Note: For spaces fewer than 5, it is more code efficient to enter spaces instead of the @B command.

Example - Building on the previous example, we’ll center the “MSI 6000” on a 20 column printer:

```
@B06␣4␣MSI 6000␣␣5␣
```

The @B06 command printed 6 spaces followed by “MSI 6000” in red expanded characters.

@C PRINT PRODUCT CODE NUMBER (MSI-6000) or PRINT ID CODE NUMBER (MSI-3650)

Purpose:

Use the @C command to cause the output to send the current product code number.

Input Data Form:

@C1 to print the Product / ID Code number plus descriptor
@C2 to print the Product / ID Code number only

Output Data Form:

@C 1

P	R	O	D	U	C	T		#			4
1	2	3	4	5	6	7	8	9	10	11	12

MSI-6000

Length: 12 Justification: "PRODUCT" left justified, number right justified. Character 8 always a space.

The number can vary from 0 to 999 depending on the current PC# that the scale is set in.

@C 1

I	D		C	O	D	E		#			4
1	2	3	4	5	6	7	8	9	10	11	12

MSI-3650

Length: 12 Justification: "ID CODE" left justified, number right justified. Character 8 always a space.

The number can vary from 0 to 999 depending on the current ID# that the scale is set in.

@C 2

		4
1	2	3

Length: 3 Justification: right.

The number can vary from 0 to 999 depending on the current PC# that the scale is set in.

@D PRINT DATE

Purpose:

Use the @D command to print the date register of the real time clock/ calendar.

Input Data Form:

@D1 Full alpha date in the form DDMMYY (ex. 25JUL92)

@D2 Print date in the form MM/DD/YY (ex. 07/25/92)

@D3 Print date in the form DD/MM/YY (ex. 25/07/92)

@D4 Print the day of the week (ex. WEDNESDAY)

Output Data Form:

@D1

2	5	J	U	L	9	2	
1	2	3	4	5	6	7	8

Length: 8 Justification: left, leading day zero suppressed.

@D2

	7	/	2	5	/	9	2
1	2	3	4	5	6	7	8

Length: 8 Justification: full, leading month zero suppressed.

@D3

2	5	/	0	7	/	9	2
1	2	3	4	5	6	7	8

Length: 8 Justification: full, leading day zero suppressed.

*@D4

W	E	D	N	E	S	D	A	Y	
1	2	3	4	5	6	7	8	9	10

Length: 10 Justification: left.

@E PRINT End of Line

Purpose:

Use the @E command to output the end-of-line string. The EOL string is entered in the printer Format section.

Input Data Form:

@E

Output Data Form:

Sends out the EOL string. Usually a Carriage Return or Line Feed, or both, ETX, etc. Can include formatting commands. See Format.

@H PRINT HORIZONTAL TABS

Purpose:

Use the @H command to send a series of Tabs. Can be used to position data on a label without having to enter multiple spaces. Not all printers support tabs. Check with printer manual for proper application of tabs in printer formatting.

Input Data Form:

@Hxx where x is any number from 01 to 99 which equals the number of tabs desired.

Note: You must enter two digits following the “@H”.

Output Data Form:

x tabs are printed (limited to 99). For more tabs use two @H commands in series.

@I PRINT SCALE ID

Purpose:

Use the @I command to print the scale ID number. Probably most important when multiple scales are in the area and there is a need to identify which scale supplied the data.

* applies only to software versions 9.67 and above

Input Data Form:

- @I1 Print scale ID# (0-255) and descriptor
- @I2 Print scale ID# (0-255) only

Output Data Form:

@I1

S	C	A	L	E		I	D		1	2	3
1	2	3	4	5	6	7	8	9	10	11	12

Length: 12 Justification: word left, number right, leading zeros suppressed.

@I2

1	2	3
1	2	3

Length: 3 Justification: right.
(expanded memory option only)

@L PRINT PRODUCT CODE

Purpose:

Use the @L command to print the one or both of the product code labels. Two unique 20 byte print strings are available to each product code. These strings can be edited to include print commands or text dedicated to that particular product code.

Input Data Form:

- @L1 Print Product Code Label 1
- @L2 Print Product Code Label 2

Output Data Form:

The printer will execute the commands or print the text contained in the 20 byte label.

@M PRINT WEIGHING MODE

Purpose:

Use the @M command to print either the current weighing mode or to print the internal mode strings.

Input Data Form:

- @M1 Print current displayed weighing mode
- @M2 Print "GROSS"
- @M3 Print "NET"
- @M4 Print "TARE"
- @M5 Print "TOTAL"
- @M6 Print "T CNT" (Total CouNT = number of weighments totalized)
- @M7 Print "TOTAL T CNT"
- @M8 (MSI-6000 only) Print "DEV" or "% DEV"
(when target mode is in effect)

@M9 (MSI-6000 only) Print "TARGET"

Output Data Form:

@M 1

*	*	*	*	*	*
1	2	3	4	5	6

Length: 6 Justification: left.

***** = Current Displayed mode, see @M2, @M3, @M4, @M8

@M 2

G	R	O	S	S	
1	2	3	4	5	6

Length: 6 Justification: left.

@M 3

N	E	T			
1	2	3	4	5	6

Length: 6 Justification: left.

@M 4

T	A	R	E		
1	2	3	4	5	6

Length: 6 Justification: left.

@M 5

T	O	T	A	L	
1	2	3	4	5	6

Length: 6 Justification: left.

@M 6

T		C	N	T	
1	2	3	4	5	6

Length: 6 Justification: left.

@M 7

T	O	T	A	L		T		C	N	T	
1	2	3	4	5	6	7	8	9	10	11	12

Length: 12 Justification: left.

@M 8

D	E	V			
1	2	3	4	5	6

(MSI-6000 Only)

Length: 6 Justification: left.

@M 8

%		D	E	V	
1	2	3	4	5	6

(alternate)

Length: 6 Justification: left.

@M 9

T	A	R	G	E	T
1	2	3	4	5	6

(MSI-6000 Only)

Length: 6 Justification: full.

@N PRINT PRODUCT / ID NAME

Purpose:

Use the @N command to print the Product / ID Name associated with the current Product / ID Code.

Input Data Form:

@N

Output Data Form:

N	A	M	E				
1	2	3	4	5	6	7	8

Length: 8 Justification: left.

@S PRINT STRING

Purpose:

Use the @S command to output the preprogrammed strings. See FORMAT in the PRINT SETUP menu.

Input Data Form:

@S Print SOL String

Output Data Form:

Sends out the SOL.

@T PRINT TIME

Purpose:

Use the @T command to print the current time register from the Real-Time-Clock.

Input Data Form:

- @T1 12 hour format with HH:MM
- @T2 12 hour format with HH:MM:SS
- @T3 24 hour format with HH:MM
- @T4 24 hour format with HH:MM:SS

Output Data Form:

@T1

	2	:	0	8		P	M
1	2	3	4	5	6	7	8

Length: 8 Justification: full, leading hours zero suppressed.

@T2

	2	:	0	8	:	3	6		P	M
1	2	3	4	5	6	7	8	9	10	11

Length: 11 Justification: full, leading hours zero suppressed.

@T3

1	4	:	0	8
1	2	3	4	5

Length: 5 Justification: left, leading hours zero suppressed.

@T4

1	4	:	0	8	:	3	6
1	2	3	4	5	6	7	8

Length: 8 Justification: left, leading hours zero suppressed.

@U PRINT CURRENT UNITS

Purpose:

Use the @U command to output the current weight units.

Input Data Form:

@U

Output Data Form:

@U

L	B		
1	2	3	4

K	G		
1	2	3	4

O	Z		
1	2	3	4

G			
1	2	3	4

L	B	O	Z
1	2	3	4

T	R	O	Z
1	2	3	4

(TROZ Special Order)

@U (MSI-3650 Only)

D	A	N	
1	2	3	4

T	N	E	
1	2	3	4

T	O	N	
1	2	3	4

Length: 4 Justification: left

@V PRINT WEIGHT VALUE

Purpose:

Use the @V command to print the current weight without units or mode printed.

Input Data Form:

- @V1 Displayed weight (GROSS, NET, DEV, %DEV)
- @V2 Gross weight
- @V3 Net weight
Note: will print dashes if NET mode is not enabled
- @V4 Tare weight
Note: will print dashes if no TARE value has been established
- @V5 Total weight
- @V6 n Totals (weighments counter)
- @V7 Total + n Totals

The following are available on the MSI-6000 only:

- @V8 Deviation from Target
(in weight or per cent depending on display mode)
Note: will print dashes if TARGET mode is not enabled
- @V9 Target weight
Note: will print dashes if TARGET mode is not enabled

Output Data Form:

@V1, @V2, @V3,

@V4, @V8, @V9

		2	0	.	5	0	2
1	2	3	4	5	6	7	8

Length: 8 Justification: right justified, character 8 usually a space.

@V5

1	2	3	4	5	6	7	.	8	9
1	2	3	4	5	6	7	8	9	10

Length: 10 Justification: right, leading zeros suppressed.

@V6

	1	2	3	4
1	2	3	4	5

Length: 5 Justification: right, leading zeros suppressed.

@V7

TOTAL VALUE										# OF WEIGHMENTS					
1	2	3	4	5	6	7	.	8	9	,		1	2	3	4
1	2	3	4	5	6	7	8	9	10	11	12	13	14	15	16

Length: 16 Justification: each number field - right, leading zeros suppressed.

@W PRINT WEIGHT FULLY

Purpose:

Use the @W command to print the current weight with units and mode printed.

Input Data Form:

- @W1 Displayed weight
- @W2 Gross weight
- @W3 Net weight
Note: will print dashes if NET mode is not enabled
- @W4 Tare weight
Note: will print dashes if no Tare value has been established
- @W5 Total weight
- @W6 n Totals (weighments counter)
- @W7 Total with n Totals (weighments counter)

The following are available on the MSI-6000 only:

- @W8 Deviation from Target
(in weight or per cent depending on display mode)
Note: will print dashes if TARGET mode is not enabled
- @W9 Target weight
Note: will print dashes if TARGET mode is not enabled

Output Data Form:

@W1

WEIGHT								UNITS						MODE					
		2	0	.	0	0	2		L	B					*	*	*	*	*
1	2	3	4	5	6	7	8	9	10	11	12	13	14	15	16	17	18	19	20

Length: 20 Justification: Weight - right justified, Units - left justified, Mode - left justified, characters 9 and 14 always a space.

***** = Current Scale Display mode (GROSS, NET, DEV, or %DEV) Does not include Total, Tare, or Target.

@W2

WEIGHT								UNITS						MODE					
		2	0	5	.	0	8		K	G					G	R	O	S	S
1	2	3	4	5	6	7	8	9	10	11	12	13	14	15	16	17	18	19	20

Length: 20 Justification: Weight - right justified, Units - left justified, Mode - left justified, characters 9 and 14 always a space.

@W3

WEIGHT								UNITS				MODE									
1	9	5	-	1	5	.	5	L	B	O	Z	N	E	T							
2		3	4	5	6	7	8	9	10	11	12	13	14	15	16	17	18	19	20		

Length: 20 Justification: Weight - right justified, Units - left justified, Mode - left justified, characters 9 and 14 always a space.

@W4

WEIGHT							UNITS				MODE											
		1	0	.	5	0	2	L	B			T	A	R	E							
1	2	3	4	5	6	7	8	9	10	11	12	13	14	15	16	17	18	19	20			

Length: 20 Justification: Weight - right justified, Units - left justified, Mode - left justified, characters 9 and 14 always a space.

@W5

TOTALLED WEIGHT										UNITS				MODE								
	4	3	2	5	3	4	.	8	5	K	G			T	O	T	A	L				
1	2	3	4	5	6	7	8	9	10	11	12	13	14	15	16	17	18	19	20	21	22	

Length: 22 Justification: Weight - right justified, Units - left justified, Mode - left justified, characters 11,16 and 22 always a space.

@W6

WEIGHMENTS					"TOTAL COUNT"							
1	2	3	4	5	T		C	N	T			
1	2	3	4	5	6	7	8	9	10	11	12	

Length: 12 Justification: Counts - right justified, Mode - left justified, characters 1, 6 and 12 always a space.

@W7

TOTALLED WEIGHT										UNITS				MODE												
	4	3	2	5	3	4	.	8	5	K	G			T	O	T	A	L	,							
1	2	3	4	5	6	7	8	9	10	11	12	13	14	15	16	17	18	19	20	21	22					
										WEIGHMENTS					"TOTAL COUNT"											
										1	2	3	4	5	T		C	N	T							
										23	24	25	26	27	28	29	30	31	32	33	34					

Length: 34 Justification: Weight - right justified, Units - left justified, Mode - left justified, Weighments right justified, "T CNT" left justified, characters 11,16 and 34 always a space.

@W8

WEIGHT								UNITS						MODE					
			0	.	8	2	0	L	B					D	E	V			
1	2	3	4	5	6	7	8	9	10	11	12	13	14	15	16	17	18	19	20

(MSI-6000 Only)

Length: 20 Justification: Weight - right justified, Units - left justified, Mode - left justified, characters 9 and 14 always a space.

@W8 (ALT)

WEIGHT								UNITS						MODE					
			0	.	8	2	0	L	B					%	D	E	V		
1	2	3	4	5	6	7	8	9	10	11	12	13	14	15	16	17	18	19	20

(MSI-6000 Only)

Length: 20 Justification: Weight - right justified, Units - left justified, Mode - left justified, characters 9 and 14 always a space.

@W9

WEIGHT								UNITS						MODE					
			5	.	5	2	0	K	G					T	A	R	G	E	T
1	2	3	4	5	6	7	8	9	10	11	12	13	14	15	16	17	18	19	20

(MSI-6000 Only)

Length: 20 Justification: Weight - right justified, Units - left justified, Mode - left justified, characters 1, 9 and 14 always a space.

REAL TIME CLOCK/CALENDAR

A clock/calendar for full time and date stamping is installed with the RS-232 option. The Clock can be set to automate weighing functions to time and date. When the scale is not being used, a digital clock display can be enabled. The Real Time Clock/Calendar is adjusted in the Main Setup Menu.

TIMEDATE SETUP MENU (IN MAIN SETUP MENU)

Top Menu	Sub-Menu	Selections
FILTER	See 3650 / 6000 Manual	
CONTRAST	See 3650 / 6000 Manual	
TIMEDATE	SET	HOUR, MINUTES, MONTH, WEEKDAY, DATE, YEAR
	MODE	12HR/MIN, 12HR/SEC, 24HR/MIN, 24HR/SEC
	CLOCK	ENABLED, DISABLED

To set the Time and Date:

	MSI-6000	MSI-3650
1) Push SETUP. Wait 2 seconds (or push SETUP again).		
2) The message reads "FILTER". Push the UP key until the message reads TIMEDATE. Push ENTER.	 	
3) The message reads "SET". Push ENTER.		
4) The message reads "HOUR". Push ENTER. Input the proper hour in 24 hour mode with the UP/DOWN keys. When the proper hour is displayed, push ENTER. In this example we'll push the UP key until the display reads 20 (= 8 PM)	 	
5) Follow a similar procedure for minutes, weekday, date, month and year. When finished setting all the Clock/Calendar parameters. Push EXIT three times to return to normal scale operation. Note: When entering weekday, use 1 for Sunday, 2 for Monday etc...		

MODE:

The MODE sets the display mode of the Real-Time Clock when the clock is enabled. Select “12HR/MIN” to display the time in 12 hour format with hours, minutes, and a PM indication. Select “12HR/SEC” to display the time in 12 hour format with hours, minutes, seconds, and a PM indication. Select “24HR/MIN” for 24 hour indication with hours and minutes. Select “24HR/SEC” for 24 hour indication with hours, minutes, and seconds.

CLOCK:

Select “ENABLED” to turn the scale into a clock calendar when the power is not on. The Microprocessor wakes up to update the display either every minute or every second depending on the mode selected. The processor will also check for activity on the Comm Ports to see if a Power up command is received.

COMPUTER OPERATION

The MSI-6000 / 3650 series can interface to computers via the RS-232 or RS-485 options. All functions can be controlled remotely and all Target setups can be downloaded automatically. The computer can query the scale at any time to get status, weight, or accumulated totals. In a RS-485 network, multiple scales (up to 255) can be “daisy-chained” to one or more RS-485 equipped computers for a complete scale control and data system. Scales can “talk” and “listen” to the master computer independently, or the Master computer can download commands to any or all scales on the network.

General Protocol:

The MSI-6000/3650 responds to ASCII commands that consist of a two letter mnemonic. Depending on the command, a 1 or 2 digit item selection may be required. Certain commands require user supplied data. Commands sent from a host computer can be chained together in any order. Commands are terminated by another command or by a semicolon (;). It is necessary to end a multiple command string with the semicolon as a terminator. Variable length data must be terminated by a semicolon or by another command.

Note: It is important that the final character sent to the 3650/6000 is a semicolon (;).

Duplex Operation:

The “@” commands when received by the 6000/3650 will cause the immediate transmission of the asked for data type out the same port.

@@ Print an "@"		
@B Print Blanks (spaces)	01-99	2 digits required.
@C Print Product Code # (6000) Print ID Code # (3650)	1=3 digit value + 8 char name 2=3 digit value only	1-6 on standard units expanded mem =more.
@D Print Date	1=Full Date 2=MM/DD/YY 3=DD/MM/YY 4=Day of Week	Full date has month spelled out as in 23 JAN 92.
@E Print End of Line String		Up to 4 characters Defaults to Carriage Return.
@H Print Horizontal Tabs 01-99		Actual tab length determined by printer.
@I Print Scale ID	1=3 digit value + word 2=3 digit value only	
@L Print Product Code Label	1=Label #1 2=Label #2	Each product ID has 2 dedicated print strings.
@M Print Weight Mode	1=displayed 2=GROSS 3=NET 4=TARE 5=TOTAL 6=n Totals 7=TOTAL & n Totals 8=Deviation 9=Target	8&9 MSI-6000 only.
@N Print Product Name (6000) Print ID Name (3650)		Prints current ID/PC number product name.
@S Print Start-of-Line string		
@T Print Time (current)	1=12HR/MIN 2=12HR/MIN/SEC 3=24HR/MIN 4=24HR/MIN/SEC	
@U Print Units (current)		
@V Print Weight Value only	1=displayed 2=GROSS 3=NET 4=TARE 5=TOTAL 6=n Totals 7=TOTAL & n Totals 8=Deviation 9=Target	8&9 on MSI-6000 only.
@W Print Weight Fully	1=displayed 2=GROSS 3=NET 4=TARE 5=TOTAL 6=n Totals 7=TOTAL & n Totals 8=Deviation 9=Target	8&9 on MSI-6000 only.

AO	Auto Off	1= Disabled 2=10 Min 3=30 Min 4=1 Hour 5=2 Hours 6=4 Hours 7=8 Hours 8=24 Hours	Once the scale is off, the computer will not be able to talk to it unless the Clock Mode is enabled.
BL	Back Light	1= Automatic 2=On 3=Off	
BR	Brightness of Backlight	1=Low 2=Medium 3= High	Not Available on units equipped with the 2nd Comm Port option.
CD	Comm Port Data	Up to 190 characters	Send CD followed by all '@' commands + text. Must be ended with a ";" (semicolon).
CE	Enable Comm Port (for receiving control formatting)	1=Comm Port 1 2=Comm Port 2	All @ and C commands will be directed to the last enabled port.
EM	Total Mode (MSI-6000 only)	1=Disabled 2=Manual 3=On Accept 4=Auto Norm 5=Auto Peak	
EM	Total Mode (MSI-3650 only)	1=Disabled 2=Manual 3=Auto Norm 4=Auto Peak	
FL	Filter	1=Low Filter 2=Med Filter 3=High Filter	
GH	Bar Graph 100% value (MSI-3650 only)	Enter value = to 100%	Terminate Value with any command or a ";" (semicolon).
GL	Bar Graph LED's (MSI-6000 only)	1=Disabled 2= Enabled	
GM	Bar Graph Mode (MSI-3650 only)	1=Disabled 2=Per Cent 3=Level (option only)	
GZ	Bar Graph 0% value (MSI-3650 only)	Enter value = to 0%	Terminate Value with any command or a ";" (semicolon).
ID	ID/Product Code Number	Enter number desired	Terminate Value with any command or a ";" (semicolon).
IE	ID/Product Code Enable	1=Disabled 2=Enabled	

IL	Product Code LC Display Mode MSI 6000	1=Disabled 2=Deviation 3=Actual Wgt 4=Δ Per Cent	MSI-6000 Only.
IL	ID Code LC Display Mode MSI 3650	1=Disabled 2=Normal 3=Per Cent	MSI-3650 Only.
IN	ID/Product Code Name	Input up to an 8 character name	End with ";" (semicolon) if less than 8 characters.
KE	Keyboard	1=Disabled 2=Enabled	Disables all front panel switches.
KF	Keyboard Function Emulate	1=Power 2=Zero 3=Gross 4=Net 5=Tare 6=Total 7=View Total 8=Clear Last Total 9=Clear Total (current ID/PC) 10=Clear all Totals 11=Print 12=Target (6000) 12=Peak Hold On (3650) 13=Peak Hold Off (3650)	Terminate Value with any command or a ";" (semicolon).
LI	Listen	0=Listen Always (all scales) 1-255 (Scale ID#)*	* to cause only the selected scale to listen
LM	Lock Mode	0=Unlock 1=Lock Mode 1 2=Lock Mode 2 3=Lock Mode 3	See the manual for a description of the 3 lock modes.
LV	Lock Value	Up to 4 numbers for a lock code	Terminate Value with any command or a ";" (semicolon).
O	Turn on the Power	None	Clock mode must be enabled.
PR	Print	1=Print Comm port 1 string 2=Print Comm port 2 string 3=Print Both	Causes the current print format strings to be printed.
RD	Real Time Calendar Date Set	Enter date in MM/DD/YY order	
RE	Real Time Clock/Calendar Enable	1=Disabled 2=On	Turns on Clock Calendar when power is off and enables scale-off data reception.
RM	Real-Time Clock Display Mode (formatting for LCD only, see @T for time formatting the print)	1=12HR/MIN 2=12HR/MIN/SEC 3=24HR/MIN 4=24HR/MIN/SEC	
RT	Real Time Clock Set	Enter time in HH:MM:SS order	

S# Set Point Receive Data Enable 1-8 for Set Points 1 through 8		S#1 to S#8 enables each setpoint. The last enabled setpoint receives any setpoint data or parameters.
SE General Set Points Mode Enable	1=Disabled 2=Normal 3=Grading 4=Bar Graph Set Points Mode	4 on MSI-6000 only. Converts SP4,5 and 6 = to Under, Accept, and Over.
SH Set Point Hysteresis	0-255	Hysteresis in scale increments.
SM Set Point Mode	1=Disabled 2=Gross 3=Net/Gross 4=Total	
SR Set Point Response	1=Normal 2=Blank LCD 3=Blink LCD 4=Message	
SV Setpoint Value	> or< followed by Weight in current units. (ex. SV>100;)	Terminate weight value with a semicolon or another command.
TA Tare	Input Tare Value in displayed units.	See "KF5" for Auto Tare.
TH Target High Limit (MSI-6000 only)	Input High Limit	Enter Δ wgt from target.
TL Target Low Limit (MSI-6000 only)	Input Low Limit	Enter Δ wgt from target.
TO Over Bargraph sensitivity (MSI-6000 only)	1 to 200 where 1=.5d	
TU Under Bargraph sensitivity (MSI-6000 only)	1 to 200 where 1=.5d	
TV Target Value	Input Target Value in displayed units.	See "KB2" for Auto Target.
UM Units print mode	1= upper case 2=lower case	
UN Set Units (MSI-6000)	1=lb 2=kg 3=reserved 4=reserved 5=oz 6=g 7=lb oz	
UN Set Units (MSI-3650)	1=lb 2=kg 3=tons 4=metric tons (tne) 5=oz 6=g 7=daN 8=lb-oz	

US Define the User Key (MSI-6000)	1=Disabled 2= Test 3=Total 4=Net/Gross	Enabling Total forces the User key to be Total. Change after enabling total if this is not what you want.
US Define the User Key (MSI-3650)	1=Disabled 2=ID # 3=Units 4=Peak Hold	

MSI-6000/3650

Relay Output Option

INTRODUCTION

This option adds 7 SPDT Relays and 1 Logic Level output to the MSI-6000 / 3650. The relays can be used in conjunction with alarms, motors, and other control circuitry to provide a complete automated production line, or to provide additional information to the scale operator.

FUNCTION

The total of 8 setpoint outputs are addressable through the setpoint routines of the MSI-6000 / 3650. Each setpoint output is fully programmable to respond to weight changes. This manual is intended to cover the electromechanical details of hooking up and using the setpoint outputs. For details on programming the set-points, refer to the MSI-6000 / 3650 User Manual.

ELECTRICAL SPECIFICATIONS

Contacts:	Form C, 1 Normally open, 1 Normally closed contact
Contact Rating:	2A 30V DC, 0.6A 110V DC, 1A 125V AC (not rated for 240VAC!)
Max Power:	60W, 125VA
Expected Life:	Mechanical 10 ⁸ Cycles
	Electrical 10 ⁵ Cycles @ 0.5A 125V AC resistive
Fuse:	1A 125V rated SMD fuse (MSI P/N 10XXX)
Isolation:	280VAC 50/60 Hz
Logic Output:	1 Normally High Output, 1 Normally Low Output (Complementary)
Fanout:	1 TTL Load, 25 CMOS Loads

RELAY CABLING

The Relay connections are made into terminal blocks found on the circuit board internal to the MSI-6000 / 3650. Due to washdown requirements, use round cable that has an outside diameter of .187" to .312" (5mm to 8mm) for proper sealing with the watertight fittings. The terminal blocks are suitable for wires from 16 to 24 gauge. There are up to three watertight fittings dedicated to the Set-Point Outputs. Multiple conductor cable will be necessary to access all of the relays.

CABLE INSTALLATION PROCEDURE

- 1) Remove the 10 screws holding the rear panel on. (Front Panel on 3650)
- 2) Strip the outer insulation from the cable. Peel back the foil shield (if any) being careful not to nick the conductors. Cut off the foil shield leaving the drain wire intact. Strip 3/16" (5mm) from each conductor and tin the wires (*Note*: it is important to tin the wires). Slip a piece of sleeving over the drain wire and tin the end of the drain wire. It is also wise to shrink a short piece of heat shrink tubing over the end of the outer jacket to further insulate the shield.
- 3) Loosen the watertight feedthrough and remove the white plug. Feed the cable through the watertight feedthrough.
- 4) Loosen the screws on the terminal block TB1, TB3, or TB5. Insert the wires as shown in the following diagram. On the MSI-6000 it will be necessary to use needle nose pliers to insert the wires into the side of the terminal strips. Screw down each wire with a small screwdriver. After all the pins are connected, lightly wiggle and tug on each wire to ensure that they are securely attached. Retighten the screws as necessary.
- 5) Tighten the watertight feedthrough around the outer insulation to ensure the water seal.
- 6) Replace the back panel being careful to seat the gasket evenly around the lip of the cabinet. Screw down the 10 backpanel (front panel on 3650) screws in a crisscross pattern to seat the gasket evenly.



Caution: Potentially fatal voltages are present within the meter! Always remove power from the meter and from your circuit before opening the cabinet and connecting or servicing the relay circuits. Ensure that the conductors to your circuit are securely fastened in the terminal block and that the cable is securely fastened in the watertight fitting. Make sure that your wiring complies with all local electrical codes.

RELAY APPLICATIONS

Some examples of uses for the setpoint relays are: Using the normally open position of a set point as a switch to turn on a light or siren when the set point is reached, using the normally closed position to cut out a motor when a set point is reached, or using the set point relays to change speeds on a motor. See figure 1 for an example hook up to a lamp. The normally open (NO) contact of a relay is used to turn devices on when a set point is reached, while the normally closed (NC) contact is used to turn a device off when the set point is reached. The common (COM) contact connects the power to the relay.

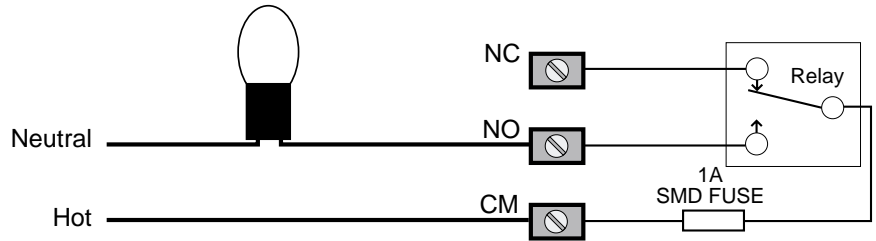

Figure 1: Turn on a Lamp when the Setpoint is Reached

Setpoints are often used in conjunction with automatic conveyer belts. By using the setpoint relays conveyer belts can be controlled by weight. Using two setpoints allows speed control for dribbling or speeding up, etc.. Figure 2 shows a simple arrangement where the motor is turned off when a setpoint is reached. Pay attention to the current and voltage ratings of the relay when using them for motor control. It may be necessary to use a boost relay externally as in figure 3.

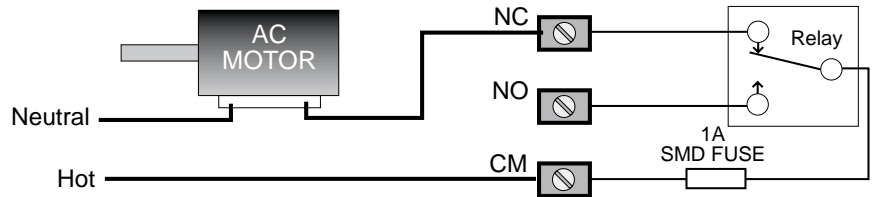

Figure 2: Cut Off a Motor when the Setpoint is Reached

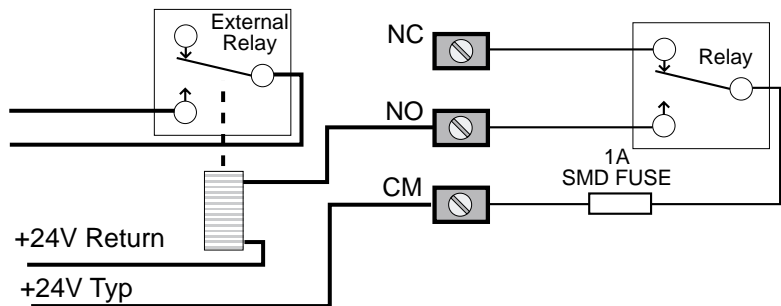

Figure 3: Powering an External Relay for Higher Voltage or Higher Power

By combining the relay outputs of 2 or more setpoints, complex in limits, out of limits, and speed controls can be implemented. In figure 4, two setpoint outputs are combined to cut off a motor when the weight is outside two limits. In figure

5 two relays are combined to turn on a motor when the weight is outside two limits.

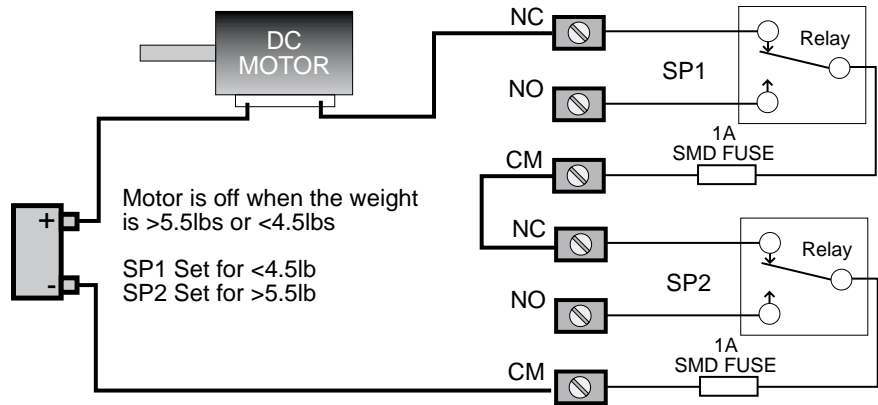

Figure 4: Cut Off a Motor when the Weight is Out of Limits

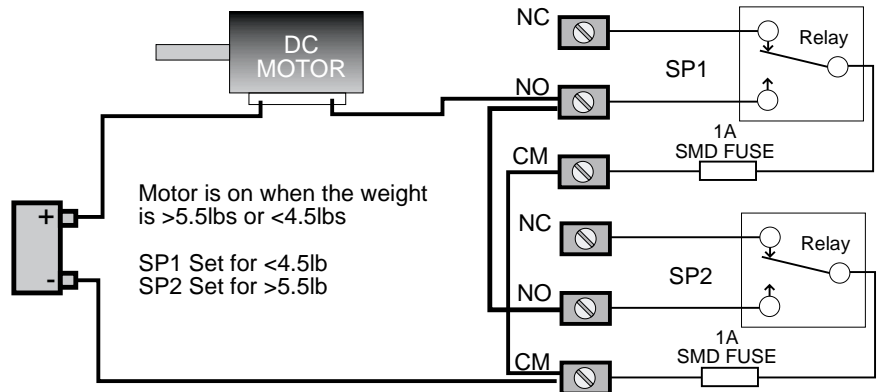

Figure 5: Turn On a Motor when the Weight is Out of Limits

Programmable Logic Controllers (PLC's) are in common use for machinery control. The 6000/3650 can interface to PLC's with the relay outputs or with the logic output on setpoint 8. Figure 6 shows one possible way of interfacing to a PLC. More sophisticated PLC's are able to take data directly from RS-232 and integrate the data into the control process. See the RS-232 option section for details.

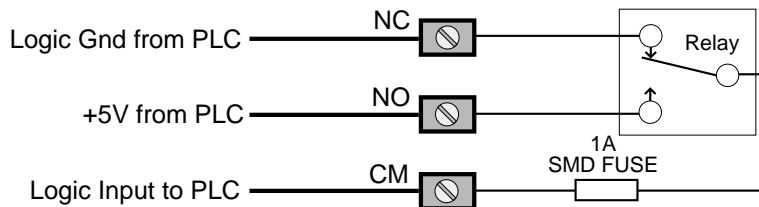

Figure 6: Isolated Interface to a PLC

LOGIC OUTPUT (SETPOINT 8)

Setpoint 8 is unique from Setpoints 1-7. The output consists of a logic output capable of driving standard TTL loads. As the output is in reality 4000B series CMOS devices, it may be necessary to provide an external pull-up resistor in certain cases. Values of $1k\Omega$ to $4.7k\Omega$ usually will suffice. There are two complementary outputs as shown in Figure 7. The TTL Hi output goes high when the setpoint is tripped. The TTL Lo output goes low when the output is tripped. The logic output ground must be connected to provide a reference level. Output level is nominally 5V but can vary from 4.8 to 5.2V.



WARNING: Do not connect any voltage outputs to the Logic Output Pins. They are protected for up to 15V only. The Logic Output should be interfaced only with logic inputs.

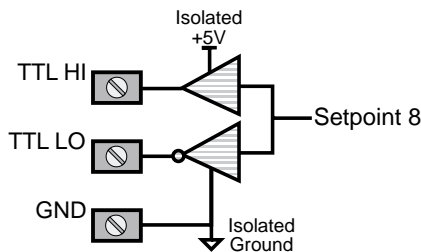

Figure 7: Setpoint 8

Besides providing a direct logic output to PLC's or other controllers, the logic output can be used to drive external relays. Figure 8 shows an example of the logic output driving an external N-channel MOSFET which can turn on a high-power relay.

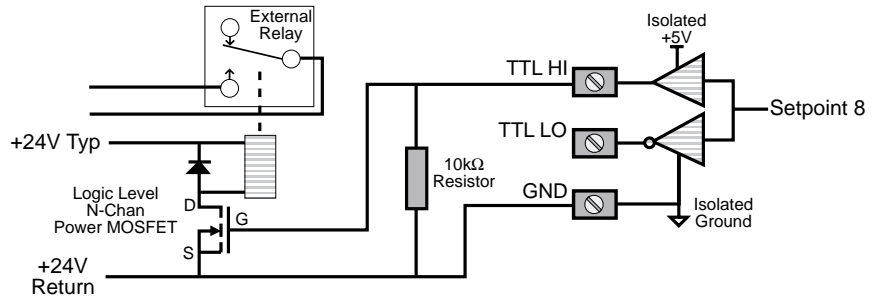

Figure 8: Driving External Relays with Setpoint 8

TEST SETPOINT RELAYS

To test the connections and exercise the relays use the following procedure:

- 1) Push SETUP followed immediately by the UNITS (6000) or TEST (3650) key. You are now in the SETPOINTS menu.
- 2) Use the DOWN key to scroll to the “TEST SP” selection. Push ENTER.
- 3) Use the UP key to step progressively through each setpoint. Each relay will turn on in succession and the message display indicates which setpoint relay is activated.
- 4) When done testing the relays push EXIT twice to return to normal scale operation.



Caution: This procedure will turn on and off any device connected to the relays. Make sure that doing so will not cause a safety hazard or damage property or goods.



Caution!!!

Relay contacts are not rated for 230VAC. Use external boost relays for higher voltage than 125VAC or higher current than 1A. See complete specifications for relay ratings.

OPTION BOARD USER CONNECTIONS

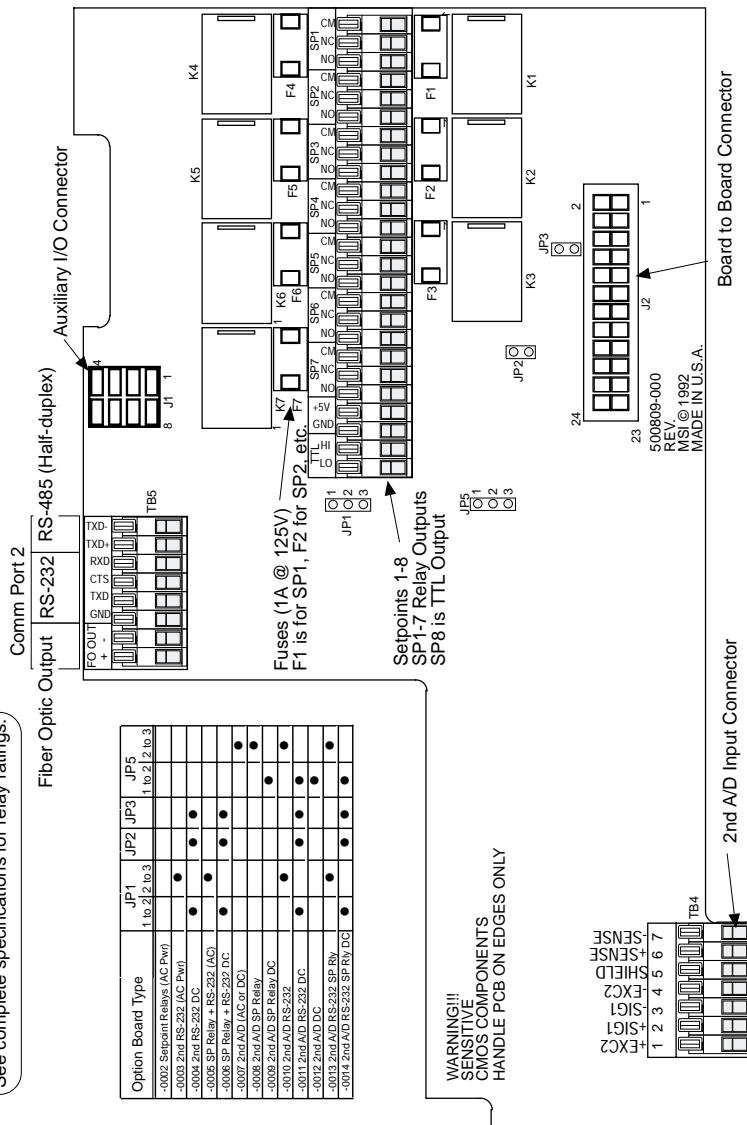

Figure 10: Setpoint Relays Wiring Diagram

ASCII TABLE

DEC	HEX	CHAR	DEC	HEX	CHAR	DEC	HEX	CHAR	DEC	HEX	CHAR
0	00	^@ NUL	32	20	SPC	64	40	@	96	60	'
1	01	^A SOH	33	21	!	65	41	A	97	61	a
2	02	^B STX	34	22	"	66	42	B	98	62	b
3	03	^C ETX	35	23	#	67	43	C	99	63	c
4	04	^D EOT	36	24	\$	68	44	D	100	64	d
5	05	^E ENQ	37	25	%	69	45	E	101	65	e
6	06	^F ACK	38	26	&	70	46	F	102	66	f
7	07	^G BEL	39	27	'	71	47	G	103	67	g
8	08	^H BS	40	28	(72	48	H	104	68	h
9	09	^I HT	41	29)	73	49	I	105	69	i
10	0A	^J LF	42	2A	*	74	4A	J	106	6A	j
11	0B	^K VT	43	2B	+	75	4B	K	107	6B	k
12	0C	^L FF	44	2C	,	76	4C	L	108	6C	l
13	0D	^M CR	45	2D	-	77	4D	M	109	6D	m
14	0E	^N SO	46	2E	.	78	4E	N	110	6E	n
15	0F	^O SI	47	2F	/	79	4F	O	111	6F	o
16	10	^P DLE	48	30	0	80	50	P	112	70	p
17	11	^Q DC1	49	31	1	81	51	Q	113	71	q
18	12	^R DC2	50	32	2	82	52	R	114	72	r
19	13	^S DC3	51	33	3	83	53	S	115	73	s
20	14	^T DC4	52	34	4	84	54	T	116	74	t
21	15	^U NAK	53	35	5	85	55	U	117	75	u
22	16	^V SYN	54	36	6	86	56	V	118	76	v
23	17	^W ETB	55	37	7	87	57	W	119	77	w
24	18	^X CAN	56	38	8	88	58	X	120	78	x
25	19	^Y EM	57	39	9	89	59	Y	121	79	y
26	1A	^Z SUB	58	3A	:	90	5A	Z	122	7A	z
27	1B	^[ESC	59	3B	;	91	5B	[123	7B	{
28	1C	^\ FS	60	3C	<	92	5C	\	124	7C	
29	1D	^] GS	61	3D	=	93	5D]	125	7D	}
30	1E	^^ RS	62	3E	>	94	5E	^	126	7E	~
31	1F	^_ US	63	3F	?	95	5F	_	127	7F	DEL

NOTES

THE MSI LIMITED WARRANTY

MEASUREMENT SYSTEMS INTERNATIONAL, INC., WARRANTS load sensing elements and meters against defects in workmanship and materials for a period of one year from date of purchase and warrants electrical cables and batteries against the same defects for a period of ninety (90) days from date of purchase.

Any device which proves defective during the warranty period will be replaced or repaired at no charge; provided that the defective device is returned to the Company freight prepaid.

In no event shall the Company be liable for the cost of any repairs or alterations made by others except those repairs or alterations made with its specific written consent, nor shall the Company be liable for any damages or delays whether caused by defective workmanship, materials or otherwise.

The Company shall not be liable for any personal injury or property damage resulting from the handling, possession or use of the equipment by the customer.

The warranty set forth herein is exclusive and is expressly in lieu of all other warranties, express or implied, including without limitation any implied warranties of merchantability or fitness, or of any other obligations or liability on the part of the Company.

The liability of the Company under this warranty is limited solely to repairing or replacing its products during the warranty periods; and the final judgement and disposition of all claims will be made by MEASUREMENT SYSTEMS INTERNATIONAL, INC.



©1996 by Measurement Systems International
Printed in U.S.A.
PUB. 229-05-93A



14240 INTERURBAN AVENUE SOUTH STE. 200
SEATTLE, WASHINGTON 98168-4661 U.S.A.
206-433-0199 • FAX: 206-244-8470