

MSI3650

DIGITAL WEIGHT
INDICATOR

**ONLINE PRODUCT
WARRANTY REGISTRATION**

Click here to activate your
MSI Product Warranty today.

www.msiscales.com

User Guide

*Quality
Industrial
Weighing
and Force
Measurement
Equipment*



*Measurement
Systems
International*

TABLE OF CONTENTS

INTRODUCTION	4	Changing the Filter Setting	26
MSI 3650 LIQUID CRYSTAL DISPLAY	4	CONTRAST	27
FEATURES	5	Adjust the LCD Contrast	27
BATTERIES (Option)	6	SETUP ID CODES	27
Installing/Changing	6	ID Codes Setup Menu	28
Low Battery Indication	6	ID Code	28
LOAD CELL HOOKUP	6	Set the ID Code	28
OPERATION GUIDE	7	ID Name	29
POWER	7	Add or Edit a ID Code Name	29
ZERO	8	NUM DISP	30
NET/GROSS	8	Change the Numeric Display Mode	30
TARE	9	SETUP POWER	31
Auto Tare	10	AUTO OFF	31
Clear the Auto Tare Value and return to GROSS	11	LIGHTING (Backlight option)	31
Manual Tare	11	Turn on the Backlight	32
Use TARE UP/DOWN	12	DISPLAY BRIGHTNESS	32
SETUP TARE MENU	12	BARGRAPH MENU	32
Change the mode of the Tare key	13	Turn on the Bargraph	33
Multiple Tare Memory	13	SET POINTS MENU	34
TOTAL	13	SET PTn	34
TOTALIZE MENU (Setup Total)	15	SP MODE	34
Σ Mode	15	Set Point Mode Procedure	34
Set the TOTAL Mode	16	SET PTn	35
VIEW Σ (Total)	16	Set Point Entry Procedure	35
Display the Totaled Weight	16	Disable a Set Point	36
Erase the last Totaled Weight	17	Disable all Set Points	37
Clear the Total Value	18	Using the MSI 3650 as a Grading Scale	37
CLEAR ALL TOTALS (Setup View Σ)	18	CALIBRATION	38
PRINT	19	ENABLE CALIBRATION	38
TEST	19	CALIBRATE SETUP MENU	39
USER	20	SELECT LEGAL STANDARD	39
SETUP USER MENU	20	SELECT CALIBRATION UNITS	40
LOCK	20	CALIBRATE (Standard Calibration)	40
Lock Function Table	21	Calibration Error Messages	41
Lock Operation	22	RESET CALIBRATION	42
UnLock	23	RESET ALL	42
USER DEF	23	INITIAL CALIBRATION	43
Define the User Key	23	FINE CALIBRATE	45
PEAK HOLD	24	ENABLE/DISABLE AZM	46
Capture Peak Weight Readings	24	CALIBRATION MENU MAP	47
Clear Peak Weight Readings	24	CALIBRATION FLOW CHART	48
SETUP	24	SPECIFICATIONS	49
Main SETUP Menu	25	OPTIONS	51
UNITS	25	MSI-3650 MENU MAP	53
Change the UNITS	25	MOUNTING BRACKET ASSEMBLY	55
FILTER	25	THE MSI LIMITED WARRANTY	56

INTRODUCTION

The Measurement Systems International MSI-3650 Weight Indicator represents a new level of technology and performance in the scale industry. A 16 bit microcontroller coupled with an alphanumeric display gives unprecedented versatility and programmability. In battery powered applications, advanced power saving circuitry provides typically 100 hours of operating time with 350Ω load cells (or up to 400 hours with 2000Ω load cells) from 2 ordinary “D” cell alkaline batteries. The large, backlit, alphanumeric display provides precise, unambiguous indication of operating modes such as Net, Gross, or Total. Digital calibration makes maintaining your scale a snap, and the single board, marine-proof (NEMA 4) construction makes for rugged and reliable weight indicator. To further enhance the versatility of the MSI-3650, an optional Infrared Remote Control (IR) system can access and control all the operating modes of the indicator. An option card can be plugged in which provides set points and an additional isolated RS232 port, RS485 port, or an advanced Fiber-Optic link. The MSI-3650 meets or exceeds the requirements of all regulatory agencies.

MSI 3650 LIQUID CRYSTAL DISPLAY

Backlit, transfective LCD provides excellent readability from full sunlight to darkness. The alphanumeric section prompts the operator through setup and calibration.

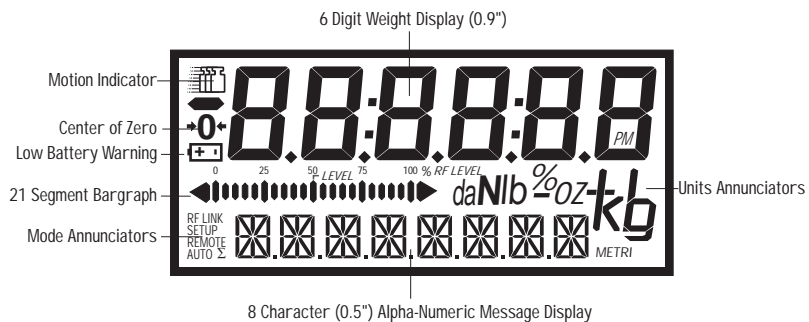

FEATURES

- Designed to meet or exceed all U.S. and International standards.
- Precise high resolution 20 bit A/D conversion coupled with advanced 16 bit microcontroller provides world class features and accuracy.
- Six .9 inch (22.8 mm) digits for clear weight readings from a distance.
- 10 built-in ID Codes with separate Tare, Mode, and Total Registers.
- Analog bargraph provided for relative to full-scale weight indication. Also used for electronic out-of-level indication on the MSI Lift Truck Scale System.
- Easy to read annunciation of measurement modes such as NET or GROSS are provided on eight .5 inch (12.7 mm) alphanumeric characters. Also used for menu prompts and ID messages.
- Display illumination uses rugged, long life, LED backlighting coupled with a transfective LCD provides optimum display contrast under all ambient conditions from full sunlight to total darkness. Operation is light-sensing automatic or manually set.
- Versatile power input options: AC only (90-260 VAC/45-65 Hz), Battery only (2 alkaline “D” cells), 12-48 VDC input.
- Exceptional battery life (battery powered units): Typically 400 hours (2000 Ω gages) or 100 hours (350 Ω gages) of use provided by 2 alkaline “D” cells. Maximum battery life is reduced by use of the backlighting. A typical operating cycle of 8 hours daylight use and 2 hours night use should provide 5 months of operation on a single battery change. The 3650 will automatically power down when not in use (this feature can be disabled). A low battery indication appears when approximately 10% of battery life remains. Contact the factory for more information on 2000 Ω gaged load cells.
- Easy to maintain: Full digital calibration assures reliable, repeatable measurements.
- Selectable for lbs, kg, g, tons, metric tons, dekaNewtons, ounces, and percent (units switching may be prohibited in some legal for trade units).
- Automatic or manual weight totalization for logging total throughput.
- Complete marine sealing ensures reliable operations under harsh conditions. Rugged cast aluminum package is coated to resist corrosive atmospheres. Meets all requirements of NEMA 4 and IP65.
- Anti-EMI shielding standard. Low emissions and susceptibility.
- Easily customized for special applications.
- 8 set points standard – setable for any “in-range” weight for operator alerts or process control. Optional Set point Relay outputs are available for conveyor belt or any other process control.
- 8 zone grading scale capability built in.

BATTERIES (OPTION)

Type

2 Standard “D” Cells, or 2 High Capacity Ni-Cads. With standard “D” cells, alkaline type is preferred but standard Carbon-Zinc can also be used. Using Ni-Cads or Carbon-Zinc batteries typically will cut the available battery life in half.

Installing /Changing

- 1) The batteries must have enough charge to ensure accurate operation. (2 batteries in series must total more than 1.6 V).
- 2) Turn the 3650 indicator off.
- 3) Remove the Battery Cover by turning the cap counterclockwise.
- 4) Remove the old batteries by pushing in on the battery rapidly and allowing the spring to push the batteries out. Replace the batteries with two fresh “D” cells. The negative end goes in first.
- 5) Reinstall the battery cap by turning the knob clockwise.
- 6) (Optional) The batteries can be checked with the Test Mode. Power displayed is in relative % of battery life. If the number with fresh batteries is extremely low, (less than 20%) turn off the power, remove the batteries, and check that the polarity of both batteries is correct.

Low Battery Indication

A small battery symbol will appear on the LCD when there is approximately 10% of battery life remaining. The symbol will start flashing when power failure is imminent. At this point the backlight will also turn off to conserve battery life. You must replace the batteries when the symbol starts flashing. The unit will automatically shut down if the batteries are not replaced shortly after the battery symbol starts flashing (actual time depends on load conditions).

LOAD CELL HOOKUP

- 1) Unplug the indicator, or if battery powered, remove the batteries. Remove the front panel of the indicator with a properly sized Phillips screwdriver. Note the position of the seal screw that has a side hole (lower left corner - viewed from the front).
- 2) Gently pull the front panel out and lay it down in front of the cast housing.
- 3) Loosen the right side (viewed from the back) liquid tight feedthrough connector fitting with a 3/4 inch open wrench. Feed the Load Cell cable through the liquid tight connector.
- 4) Strip and tin the Load Cell leads and attach them to the appropriate

terminals with a small screwdriver. The indicator comes standard with 4 terminal connections which are adequate for cable lengths of 50 feet (15 meters). Any shield should be connected to the shield terminal.

- 5) After pulling lightly on the wires to check for firm connection, take the slack out of the load cell cable as you close up the case.
- 6) Tighten the liquid tight feedthrough connector to ensure a watertight enclosure.
- 7) Put 2 screws in the front panel to hold it in place. Restore the power (batteries or AC).
- 8) Refer to the calibration section. If this is a first time hookup of this capacity load cell, perform the RESET CALIBRATION procedure followed by the INITIAL CALIBRATION procedure. If an identical load cell with the same capacity was replaced (or cable replaced, etc.) it should only be necessary to do a standard calibration.
- 9) If there were no calibration errors reported and the calibration is complete, install the remaining screws loosely. When all the screws are in place, tighten them down in a left, right, up, down pattern. Torque the screws evenly until all are tight. This ensures even pressure on the O-ring. If you have access to a torque driver, tighten each screw to 3-4 in/lbs.
- 10) Install the indicator bracket. (See drawing at end of manual.)

OPERATION GUIDE



Function:

Turns the Indicator On and Off.

Rules for Use:

- 1) (Battery Option Units) The batteries must have enough charge for accurate operation. (2 batteries in series must total more than 1.6 V).
- 2) Ambient temperature must be between -20° C to +60° C (-4° F to +140° F).

Operation:

- 1) Push POWER.
- 2) Display Check: All segments and the Set Point/Total LEDs illuminate for 3 seconds.
- 3) Message displays “MSI 3650”, the weight display gives the software version number (2 seconds).
- 4) During the display test and MSI message the Microprocessor tests the internal circuitry. Any test failure will produce an error message on the LCD.

Final:

Display reads the current weight in the last set mode (NET, GROSS, TOTAL, PERCENT, PEAK NET, PKGROSS).

ZERO





Function:

Sets the zero reading of the scale. Use the zero key to take out small deviations in zero when the scale is unloaded. (See “TARE SET” for zeroing (Tareing) package or pallet weights).

Rules for Use:

- 1) Only works in GROSS mode.
- 2) The scale must be stable. The scale will not zero if the motion detect annunciator is on.
- 3) The scale will accept a zero setting over the full range of the scale (NTEP and other Legal-for-Trade models may have a limited zero range). Zero settings above 4% of full scale will subtract from the overall capacity of the scale. For example if you zero out 100 lbs on a 1000 lb scale the overall capacity of the scale will reduce to 900 lbs plus the allowed over-range amount.

<p>Press ZERO. The weight reading must be stable within ± 1 division for the zero function to work. The display temporarily reads "ZEROED" and the digits display "0". The backup memory stores the zero reading, and can restore it even if power fails.</p>		
<p>Final: The numeric digits display "0" (or "0.0" or "0.00", etc.).</p>		

NET/GROSS



Function:

Toggles the display between Net and Gross modes. Net Weight is defined as Gross Weight minus a Tare Weight.

Rules for Use:

- 1) There must be a Tare weight established to switch from Gross mode to Net mode (See Tare).
- 2) NET/GROSS will work even when the scale is in motion.

Operation:

Push NET/GROSS.

- No current tare is stored (Tare = \emptyset)
No Action, display continues to read the Gross weight only
- A tare value is stored :
Toggles between Net and Gross display modes. Display reads "GROSS" or "NET".

TARE





**Function:**

Tare is typically used to zero out a known weight such as a packing container or pallet and display the load in Net weight. The Tare key is user programmable for three modes:

- 1) **AUTO TARE** – When the Tare key is pushed the current weight is zeroed and the weight display reverts to Net mode. (default mode).
- 2) **TARE UP/DOWN** – When the Tare key is pushed the UP and DOWN keys are activated. The user scrolls to the desired tare weight. When the desired weight is displayed, the user pushes the Enter key, or the Tare key.
- 3) **MANUAL TARE** – When the Tare key is pushed, the user enters the desired weight calculator style using the UP/DOWN keys and ENTER. Use the Manual Tare mode when the Tare value is more than 20% of capacity as the Tare Up/Down mode would take a while to tare off large values.

The 3650 Tare key function defaults to the AUTO TARE mode. To change to Up/Down or Manual Mode see “SETUP TARE”.

Auto Tare

<p>Press TARE. The weight reading must be stable within ± 1 division (Motion Annunciator off) and has to be a positive reading. The entire range of the scale can be Tared.</p>		
<p>Assuming no motion, the display temporarily reads "TARE SET" and then converts to a "NET" display. All following readings are deviations from the set Tare value.</p>		
		
		

Rules for Use:

- 1) Only positive weight readings can be tared. Weight can be tared in both the NET and GROSS modes. When in the NET mode, the TARE is not cumulative, all the weight is zeroed.
- 2) The motion annunciator must be off. The weight reading must be stable.
- 3) Setting or changing the tare has no effect on the zero setting.
- 4) Taring will reduce the apparent over-range of the scale. For example, taring a 10 lb container on a 60 lb scale, the scale will overload at a net weight of 50 lb (60-10) plus any additional allowed overload (usually ~4%).
- 5) The scale stores the tare value in the current I.D. Code memory until cleared. This provides a Tare memory function of 10 tare values (1 for each ID Code).

Clear the Auto Tare Value and return to GROSS mode

(use NET/GROSS to return to GROSS mode without clearing the TARE)

Press **TARE** followed quickly by **CLEAR** (TEST). The message display reads "TARE CLR". The scale returns to the Gross mode.

Alternate method: Remove all weight from the scale (Gross Zero) and press **TARE**. The message display reads "TARE CLR". The scale returns to the Gross mode.





Manual Tare

(Setup TARE key function to “MANUAL”)

- Press **TARE**. The display reads "MAN TARE".
- The Tare value, if any is displayed. Enter the desired Tare value using the **UP/DOWN** and **ENTER** keys. Use the **POWER** switch to enter a decimal point. In this example, we will enter 3.1 lbs as a tare weight.
- Finish out the Tare entry by pressing the **ENTER** key on a blank character. After entering the last number, the scale returns to operation in the Net mode.

Use TARE UP/DOWN

(Setup TARE key function to “UP/DOWN”):

<p>1. Press TARE The display reads "TAREUPDN".</p> <p>In this example we will enter 4.5 lbs as a tare weight.</p>	 TAREUPDN
<p>2. The Tare Value, if any, is displayed. Enter the desired Tare Value by holding down the UP key. The weight value will scroll up slowly for two seconds and then pick up speed. If you overshoot the value use the DOWN key to return.</p>	 0 →→→ 4.5
<p>3. Finish out the Tare entry by pressing the ENTER key or the TARE key. The scale returns to operation in the Net mode.</p> <p>Note: Entry of the Tare Value will occur after 5 seconds.</p>	 

SETUP TARE MENU



Function:

Programs the mode of the TARE key and allows manual entry of Tare and viewing the current Tare Value.

Top Menu	Selections
KEY FUNC	AUTO, UP/DOWN, MANUAL

Change the mode of the Tare key

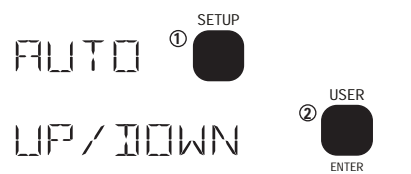
<p>1. Press SETUP followed immediately by the TARE switch. The display reads "KEY FUNC". Press ENTER.</p> <p>In this example, we will enable the "TARE UP/DOWN" mode.</p>	
<p>2. The current Tare mode is shown. Select the desired Tare mode by pressing the UP key and ENTER keys.</p> <p>The scale returns to normal operation with the Up/Down Tare mode enabled.</p>	

Multiple Tare Memory

The 3650 is capable of storing 10 (or optional 50) Tare values through the use of the ID Codes. Each ID code stores an independent Tare. (See Setup ID Codes section for more information).



Manual Total Function:

For accumulation of multiple weighments. The accumulator always uses the displayed weight, so gross and net readings can be added into the same total. There are two modes of Totalizing which are set in the SETUP TOTAL Section. The Manual mode requires that the TOTAL key is pressed when the weight currently on the scale should be added to the previously accumulated value. The AUTO Mode will automatically add the last settled value to the total. Both modes require that the scale returns to within 1% (relative to full scale) of Gross Zero or Net Zero before the next weighing can be added. Applied weight must be 2% above Gross Zero or Net Zero before it can be totaled. (See "SETUP TOTAL" for instructions to enable the AUTO TOTAL modes).

Rules for use:

- 1) The motion annunciator must be off and the scale must be stable.
- 2) Only positive readings can be accumulated.
- 3) After a weighing is totaled, the scale must return to below 1% of FS relative to Gross Zero or Net Zero before another weight can be added to the total. This assures that a weight on the scale is only added to the total once.

- 4) When the total weight exceeds the display capability of 999,999 counts, or the total weighments count exceeds 9999, dashes will appear to reflect a display overflow. If you have a RS232 option, the larger numbers can be printed through the use of the PRINT button, or with a computer hookup.

Operation:

- 1) Push TOTAL.
- 2) The current weight is added to the total register.
- 3) The scale adds the current reading (relative to the Net zero or Gross zero depending on mode) to the contents of the accumulate register.
- 4) When a value is added, the display gives an indication of how many weighments have been totaled, i.e. 1 TOTAL , 2 TOTAL , 3 TOTAL, ...x TOTAL. The total accepted LED (center right of display) will also light for 4 seconds providing additional indication that the Total command was accepted.

Auto Total Function:

SETUP Option, see “SETUP TOTAL” to enable Auto Total. When a weight threshold of 2% of FS or “Min e” (whichever is greater) above Net Zero or Gross Zero is exceeded, the total function operates automatically. The displayed weight is held in a holding register and added when the weight returns to zero ($0 \pm 1\%$ of FS). When a weight that meets the minimum accept limit settles, (no motion) the Total LED indicator will flash three times. If the weight changes to a new settled value the LED will flash again indicating that the previous settled reading has been replaced. The last settled reading is what will be used for totalizing when the scale returns to zero. The user must take caution that while removing the load the scale does not go out of motion or a possibly erroneous reading could occur. The last settled weight is actually added to the total when the scale returns to less than 1% of FS. The Total LED will flash for a steady 4 seconds indicating the weight has been totaled. The “AUTOPEAK” total mode works the same, except that the highest settled reading will be used for totalizing on return to zero, rather than the last settled reading.

Rules for Use :

- 1) Cannot be in motion. An auto total acceptable reading is indicated by three short flashes of the Total LED.
- 2) Weight readings must be greater than 2% of FS relative to Net Zero or Gross Zero.
- 3) Each reading added to total must be preceded by a return to zero (Net or Gross) $\pm 1\%$ of capacity. Totalization of the last settled weight is indicated by a 4 second flash of the Total LED.

Operation:

- 1) Enable the Auto Total mode in the “SETUP TOTAL” menu (See “SETUP TOTAL”). Select either the “AUTONORM” or the “AUTOPEAK” mode. Exit from the setup menu.
- 2) Push TOTAL. The message "TOTAL ON" appears briefly.
- 3) Place the weight to be totalized on the scale. The LED will flash three or more times when the weight is settled.
- 4) Remove the weight. The screen will read "x TOTAL" where x is the number of totaled weighments. The total key is used as a Total On/Total Off toggle key which is indicated briefly on the message display (i.e. “TOTAL ON” or “TOTAL OFF”). Auto Totalizing will only occur in the TOTAL ON mode. The Auto Total On mode is indicated by an "AUTO Σ" annunciator on the LCD .



Function:

Allows Front Panel entry of Totalization parameters.

Top Menu	Selections
Σ MODE	MANUAL, AUTONORM, AUTOPEAK, DISABLED

Σ MODE

The Manual mode requires that the TOTAL key (or IR Remote Total key) is pushed when the weight currently on the scale should be added to the previously accumulated value. The Autonorm mode will automatically add the last, settled value to the total. The Autopeak mode will automatically add the highest settled value to the total. All total modes require that the scale returns within 1% (relative to full scale) of Gross Zero or Net Zero before the next weighing can be added. Applied weight must be 2% or “Min e” (whichever is greater) above Gross Zero or Net Zero before it can be totaled. (See “TOTAL” for more details).

Set the TOTAL MODE

<p>1. Press SETUP followed immediately by the TOTAL switch.</p>	
<p>2. Press ENTER. The first menu choice is "MANUAL" (or the last set mode). In this example, we will enable the "AUTONORM" mode.</p>	
<p>3. Press the UP or DOWN key to scroll through the Total Mode options. When the desired choice is displayed, press ENTER.</p>	
<p>4. The display returns to normal operation. Enable the start of Auto Totaling by pressing the TOTAL key. The display will read "TOTAL ON" and the small "AUTO Σ" annunciator will appear.</p>	

VIEW Σ (TOTAL) 

Function:

Displays the current total value of the selected ID number and allows the total to be cleared.

Display the Totaled Weight

Press **VIEWΣ**.
The totaled weight and the number of weighments will be displayed for 4 seconds.



Erase the last Totaled Weight

If the last totaled (automatic or manual) weighing was a mistake, it can be erased with the following procedure. This erases the last weighed value only.

Note: This procedure assumes you have not modified the USER key function.









1. Push **VIEW** Σ then **CLEAR** (TEST). The message reads "x TOTAL" (where x is the number of weighments), then "CLRLAST Σ ".



2. Press **ENTER** (USER).
If you change your mind, press **EXIT** to cancel the Clear Last Total operation. The last weight totaled is subtracted and the number of weighments counter is reduced by one.



Clear the Total Value

<p>1. Press VIEWΣ then CLEAR (TEST). The message reads "x TOTAL" (where x is the number of weighments), then "CLRLASTΣ".</p>	<p>VIEW Σ ①  TEST ②  CLEAR</p>	 
<p>2. Press CLEAR again. The message reads "CLEARΣ".</p>	<p>TEST  CLEAR</p>	
<p>3. Press ENTER (USER). If you change your mind, press EXIT to cancel the Clear Last Total operation or press CLEAR to return to "CLRLASTΣ" mode. The total reading and the number of weighments counter will revert to zero.</p>	<p>USER  ENTER</p>	

At any time the EXIT key cancels the Clear operation without clearing anything.

CLEAR ALL TOTALS (SETUP VIEW Σ)



Function:

Allows Clearing all totals on all ID codes at once.

Operation:

- 1) Push **SETUP** followed immediately by the **VIEW** Σ switch. The message "CLR ALL Σ " appears.

- 2) Push ENTER. The message “RU SURE” appears.
- 3) Push ENTER to clear all the total registers. Push EXIT if you change your mind.
- 4) Push EXIT to return to normal scale operation.

Top Menu	Message	Selections
CLR ALL Σ	R U SURE	ENTER to clear, EXIT to quit



Function:

Sends the current displayed reading to the printer or selected Com Port, unless otherwise setup in the Print Setup menu. Any or all weight functions can be printed as set in the Print Setup Mode. Refer to the RS232 Option Manual for more details. Contact the factory if you have the RS232 option and do not have the Option manual.



Function:

Provides a functional system test, and an on-demand display check without disturbing the current weighment. Also provides calibration verification in the form of a load cell Calibration number.

Operation:

To start the test sequence:

Press TEST.

- 1) All digits (7 segment and 16 segment) count once from 0 to 9. All annunciators are tested including lb, kg, t. and the Total LED
- 2) Battery condition is displayed next in the form: % of Battery life with a figure from 1 to 100 on the digits. The % battery life will vary depending on whether the backlight is on or off.
- 3) Internal tests are performed to further ensure scale integrity.
- 4) The RCAL number; is displayed last. To ensure that the RCAL number is accurate the scale must be unloaded. Compare the number shown to the RCAL number noted after calibration. Deviations of more than 10 counts can indicate a problem with the scale system. RCAL ERR : On systems such as hoppers or tanks where it is impossible to unload the scale, the RCAL test will probably return the error message “RCAL ERR”. Also if the scale was calibrated without RCAL, you will also get an error message. The 3650 will still function fine, but RCAL will not function.

Final:

Either the reading returns to the pretest condition, or an error message is displayed.

RCAL Defined

RCAL is calculated by switching a precision resistor in parallel with one leg of the strain gage bridge. The resistor unbalances the bridge causing the differential voltage to rise. The voltage rise is amplified and converted to digital form by the same circuitry that the load cell is applied to. By comparing the RCAL value to previously known values, the integrity of the scale can be easily established. Large dead loads can cause the RCAL calculation to be inaccurate, so this test is best performed with the scale at or near gross zero.

USER



Function:

The operator can program the USER key function to any of 4 functions: Peak Hold, Units (default), ID Code, or disabled.
See “SETUP USER” for instructions on programming the User key function.

SETUP USER MENU



This setup menu defines what the USER key does, and enables the function.

Top Menu		Selections
LOCK	Enter up to a 4 digit lock code	LOCK 1, LOCK 2, LOCK 3
KEY FUNC		ID NUMBER, PEAKHOLD, UNITS, DISABLED

LOCK

The Lock function allows the user to lock various setups to prevent unauthorized changing or erasing of scale functions and features. For added security an optional lock code (1-4 numerals) can be inputted. Once the 3650 is locked, the message “LOCKED” will appear whenever a locked function is tried. To unlock, push the Setup key and enter the lock code number. If the lock code is lost, the calibration seal must be broken to unlock without the proper code.

In all lock modes, the ZERO, PRINT, TEST, VIEW Σ and POWER keys

always work. The three lock modes differ in what functions are still active as detailed in the following table.

Lock Function Table

Key/Function	LOCK 1	LOCK 2	LOCK 3
NET/GROSS	Functional	Functional	Locked
SETUP	Locked	Locked	Locked
(AUTO) TOTAL	Functional	Functional	Locked
USER as UNITS	Functional	Locked	Locked
USER as PK HOLD	Functional	Locked	Locked
USER as ID Codes	Functional	Functional	Locked
TARE SET/CLR	Functional	Locked	Functional

Lock 1

The LOCK 1 mode prevents only the SETUP functions and the Tare value from being modified. All other scale functions work normally. As long as the USER key is not programmed for UNITS, this lock mode would prevent anyone changing the UNITS.





Lock 2

The LOCK 2 mode disables the USER key and prevents the ID codes from changing.

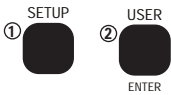

Lock 3

The LOCK 3 mode locks every setup function. Lock 3 prevents the AUTO TOTAL mode from being turned on or off with the TOTAL key. Enable or disable Auto Total before starting Lock3.

Lock Operation

<p>1. Press SETUP followed immediately by the USER switch.</p>	
<p>2. The message display reads "LOCK". Press ENTER.</p>	
<p>3. Press ENTER if no security code is needed. If a custom lock code is desired, enter up to a four digit lock code by using the UP/DOWN and ENTER keys.</p> <p>IMPORTANT! Make note of the code. In this example, no lock code is needed.</p>	
<p>4. Use the UP/DOWN keys to select the Lock mode as described above. In this example we will select LOCK2. Press ENTER.</p>	
<p>5. The menu item "KEYFUNC" appears. Press EXIT, the scale returns to normal operation except those functions that are locked. The message display reads "LOCKED" whenever a locked function is tried.</p>	

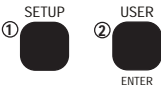

UnLock

<p>1. Press SETUP followed immediately by the USER switch.</p>	
<p>2. The message display reads "LOCK". Press ENTER.</p>	
<p>3. Use the UP/DOWN and ENTER keys to input the lock code. The code is up to 4 characters long. In this example, no lock code is needed. If the entered code is correct, the "LOCKED" annunciator will go off and the scale will return to normal operation.</p>	

USER DEF

Programs the User key function. The USER key defaults to the "DISABLED" mode. Use the USER key to provide a front panel UNITS key, enable the Peak Hold mode, or provide easy switching of ID numbers.

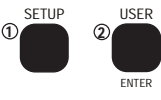
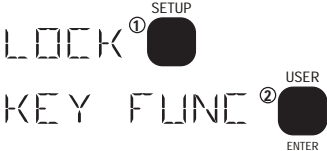
Define the User Key

<p>1. Press SETUP followed immediately by the USER switch.</p>	
<p>2. The message display reads "LOCK". Use the UP key to scroll to the "KEY FUNC" message. Press ENTER.</p>	
<p>3. Use the UP/DOWN keys to scroll through the User key options. In this example we will change the function of the User key from DISABLED (which is the default), to UNITS to allow front panel switching of weighing units with the user key.</p>	
<p>4. The display shows the menu item "LOCK". Press EXIT to return to normal scale operation.</p>	

PEAK HOLD (USER KEY OPTION)



Function:

Allows monitoring peak weight. Uses a special mode of the A/D converter for capturing transient events.

Capture Peak Weight Readings

- 1) Program the USER key for “PEAKHOLD”.
- 2) Turn on the Peak Hold mode by pushing USER. The display reads “PEAK NET” or “PK GROSS” to indicate peak hold mode is enabled. The display will only update when a greater value than previously recorded is detected.

Clear Peak Weight Readings

Turn off the Peak mode by pushing the USER key. This clears the peak value from memory. The display will revert to NET or GROSS mode.

SETUP

Function:

Allows Front Panel entry of seldom set parameters.

Operation:

Press SETUP to enter the SETUP Menu. Push SETUP again or wait 2 seconds for the Main Setup Menu to appear.

The message describes the parameter being set. To change the setting of the Parameter push ENTER. Options are viewed by repeated pushes of the UP (SETUP) or DOWN (VIEW Σ) keys. Selections are stored with the ENTER key. Pushing the EXIT key will skip all remaining parameters and return the scale to normal operation.

Note : Not all the selections below are activated on every MSI-3650. Legal-for-Trade issues and application issues require certain menu items to be under the Calibrate menu (under seal, see calibration section), and certain items to be disabled. Any or all menu items can be eliminated under software control (Contact factory for details).

Main SETUP Menu





Top Menu	Selections
UNITS	lbs, kg, Tons, Metric Tons, lbs-oz, oz, g, daN*
FILTER	LOW/MEDIUM/HIGH
CONTRAST	Eight steps with "123456" and message reading "CONTRAST"

*Tons available on capacities 2,000 lbs and over. Metric Tons available on capacities 1000 kgs and over. lbs-oz, oz, and g available on scales 250 lbs and under.

UNITS

Units can be changed by scrolling through the choices with the UP/DOWN keys and pushing ENTER when the desired unit is displayed. Alternately, program the USER key as a UNITS key (See SETUP USER MENU).

Change the UNITS



1. Press SETUP . Wait 2 seconds (or press SETUP again).	
2. The message display reads "UNITS". Press ENTER .	
3. Select the desired units by using the UP/DOWN keys to scroll through the choices. In this example, we will change from lbs to kgs. Press ENTER .	
4. You are back in the Setup menu. Return to normal scale operation (weighing in kgs) by pressing EXIT .	

FILTER

Use the **LOW** setting for most scale applications. It settles fastest and is intended for general use. Use the **MEDIUM** setting when the scale is being used under conditions that cause light to medium swinging. Use the **HIGH**

setting when there is a lot of scale motion. There is a time penalty to pay for using the HIGH setting. The user should wait at least 5 seconds to ensure that the final reading has settled (Motion indicator off). (Not available in some Legal-for-Trade systems)

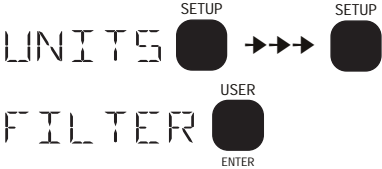

Changing the Filter Setting

<p>1. Press SETUP. Wait 2 seconds (or press SETUP again).</p>	
<p>2. The message display reads "UNITS". Press UP until the message reads "FILTER". Press ENTER.</p>	
<p>3. Select the "LOW", "MEDIUM", or "HIGH" filter by using the UP/DOWN keys to scroll through the choices. In this example, we will pick the Medium filter which is suitable from medium to high vibration conditions. Press ENTER.</p>	
<p>4. You are back in the Setup menu. Return to normal scale operations (MEDIUM Filter activated) by pressing EXIT.</p>	

CONTRAST

Used to optimize the contrast of the LCD at various viewing angles. This is factory preset for optimal viewing. By stepping through the 8 steps the contrast can be improved for off-angle or temperature extreme applications.

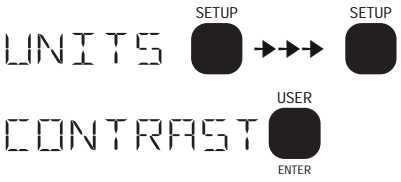
Adjust the LCD Contrast

<p>1. Press SETUP. Wait 2 seconds (or press SETUP again).</p>	
<p>2. The message display reads "UNITS". Press UP until the message reads "CONTRAST". Press ENTER.</p>	
<p>3. Adjust the contrast by pushing the UP or DOWN key until the desired display contrast is achieved. Press ENTER.</p>	
<p>4. You are back in the Setup menu. Return to normal scale operation (desired contrast activated) by pressing EXIT.</p>	

SETUP ID CODES



Function:

Allows Front Panel selection of the ID Codes. Up to 10 (50 optional) ID Codes are available. Each ID code keeps a separate Tare, Mode, and Total register. An eight letter Name can be assigned to each ID Code. The ID codes can be used as multiple Tare Memories.

Operation:

- 1) Push SETUP followed immediately by the NET/GROSS switch.
- 2) You are now in the ID CODES SETUP Menu.

ID Codes Setup Menu

ID NAME	Enter up to an 8 digit name to identify the ID Code (optional)
ID CODE	1-9 or 80 optional (use the up/down scroll keys to select)
NUM DISP	NORMAL, PER CENT, DISABLED

ID Code

Up to 9 ID Codes are available. Each ID code keeps a separate Tare, Mode, and Total register. An eight letter Name can be assigned to each ID Code.

Set the ID Code









Method 1

Programming the USER key for “ID NUM” (see USER)

- 1) Push USER. The numeric display reads “ id X” where X is a number from 1 to 9. This number is displayed for 5 seconds.
- 2) Before the 5 seconds is up, push the UP (SETUP) or DOWN (VIEW Σ) key to change the ID number.

Method 2

Using the SETUP menu





1. Press SETUP followed immediately by the NET/GROSS key.	 
2. Press UP until the message display reads "ID CODE". Press ENTER .	 
3. Use the UP or DOWN key to change the ID code number.	 
4. When the desired ID Code number is displayed, press ENTER . Return to normal scale operation (with ID Code changed) by pressing EXIT .	  

ID Name

An eight letter Name can be assigned to each ID Code. This Name is used in conjunction with the RS232 options for ID identification. The Name is optional as the ID Code will always be identified by the ID number.

Add or Edit a ID Code Name

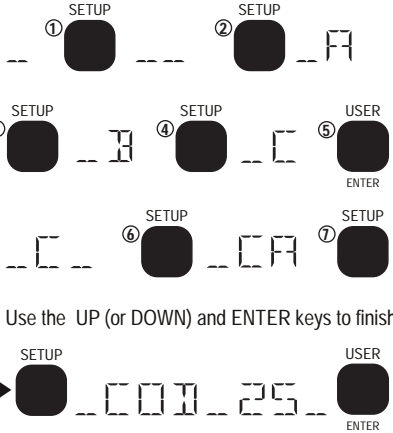
The ID can be identified with a ID CODE Name. Any combination of 8 alphanumeric characters can be stored per ID Code with the following procedure:

<p>1. Press SETUP followed immediately by the NET/GROSS key.</p>	
<p>2. The message display reads "ID NAME". Press ENTER.</p>	
<p>3. The message display will show the current ID Name with the cursor (underscore) positioned on the first character. Use the UP or DOWN key to scroll through the available character list. When the desired character is shown, press ENTER. Continue selecting characters as before. To finish the label entry, press ENTER twice.</p> <p>In this example, we will enter the word "COD 25" to represent the target being 25 lb COD cold packs. Start with a space to center the word.</p> <p>Note: When entering a character for the first time, the initial choice is a space. Pressing the UP key will start with "A". Pressing the DOWN key twice will start with the number 9.</p>	 <p>Use the UP (or DOWN) and ENTER keys to finish.</p>
<p>4. The display reads "ID CODE". Press EXIT to return to normal weighing mode or press UP/DOWN to reach the next selection.</p>	

Examples of possible labels: CHICKEN, TRUCK 7, 10PNAILS, BATCH 3, CRANE 2

Character Set:



spaceABCDEFGHIJKLMNPOQRSTUVWXYZ"\$%()*+<=>?:0123456789@ (back to "space")

NUM DISP

The function of the numeric (weight) display can be modified. The "NORMAL" setting displays standard NET or GROSS weight. The "PERCENT" setting turns the numeric display into a percentage weight meter. In the PERCENT mode, the 0% and 100% values are determined by the BARGRAPH settings (see "BARGRAPH MENU" for setting the 0% and 100% values). You must set the 0% and 100% values for the PERCENT mode to function. The "DISABLED" mode turns off the weight display altogether. This would be used when only the bargraph is desired or the meter is used to check set points only.

WARNING: Use of the "DISABLED" mode can cause confusion as the weight reading blanks out. Be sure this is what you want to do before disabling the display. If the numeric display is blanked out, push the SETUP key twice, up key to NUM DISP, push ENTER, up key to "NORMAL", push ENTER, push EXIT to return to normal operation.

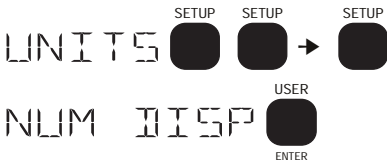
Change the Numeric Display Mode

<p>1. Press SETUP. Wait 2 seconds (or push SETUP again).</p>	
<p>2. The message display reads "UNITS". Press UP until the message display reads "NUM DISP". Press ENTER.</p>	
<p>3. Select the "NORMAL", "PER CENT", or "DISABLED" display modes by using the UP/DOWN keys to scroll through the choices. In this example we will choose the PER CENT mode. Press ENTER.</p>	
<p>WARNING! If you set the "DISABLED" mode, the weight display will be off. Use this feature carefully.</p>	
<p>4. You are back in the Setup menu. Press EXIT to return to normal scale operation (with the Percent mode selected).</p>	

SETUP POWER



Function:

Allows Front Panel entry of seldom set parameters involving power consumption.

Operation:

- 1) Push SETUP followed immediately by the POWER switch.
- 2) You are now in the SETUP Power Menu

SETUP POWER Menu

Top Menu	Selections
AUTO OFF	DISABLED , 10 MIN, 30 MIN, 1 HOUR, 2 HOURS, 4 HOURS, 8 HOURS, 24 HOURS
LIGHTING	AUTO, ON, OFF
BRIGHT	LOW, MEDIUM, HIGH







AUTO OFF

The AUTO OFF feature when enabled prolongs the battery life of the scale by turning the power off after a set time of nonuse. Depressing any key, or any change in the detected weight will reset the time limit . This feature defaults to the disabled mode when initially calibrated. When disabled the scale will stay on, only the power key (or Remote) will turn it off.

LIGHTING (BACKLIGHT OPTION)

A photocell detects ambient light and determines if the backlight should be on or off (AUTO mode). The “ON” mode turns the backlight on full time. For increased battery life, the “OFF” mode disables the backlight.

Turn on the Backlight (Setup Power operation example)

1. Press SETUP followed immediately by the POWER key.	 
2. Press the UP key to select the menu item "LIGHTING". Press ENTER .	AUTO OFF  LIGHTING  ENTER
3. Press the UP key until the message reads "ON". How many times you push the UP key is dependent on the last mode set). Press ENTER .	AUTO  ON  ENTER
4. The backlight will turn on. Press EXIT to return to normal scale operation or use the UP/DOWN and ENTER keys to change another Setup Power parameter.	 EXIT

DISPLAY BRIGHTNESS

The Fiber-Optic LED Backlight has three brightness settings. On battery powered units, use "LOW" to maximize battery life in low light situations.

BARGRAPH MENU (SETUP ZERO)



Function:







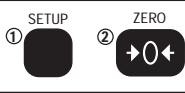

Controls the operation and calibration of the Bargraph. In conjunction with the "NUM DISP" setup mode, the BAR 0% and BAR 100% setting also control the numeric display PER CENT parameters.

Top Menu	Selections
BAR MODE	DISABLED, PER CENT, LEVEL*
BAR 0%	Enter value = to the 0 segment on the bargraph
BAR 100%	Enter value = to the 100 segment on the bargraph

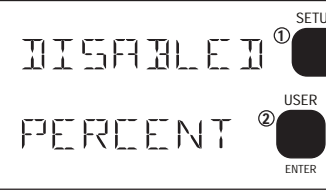
*The LEVEL mode is intended for forklift applications and is not implemented on standard 3650s. The 22 segment Bargraph can be set to any range within the capacity of the

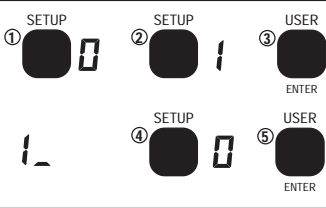
scale. Setting the 0% and 100% points to desired process parameters allows easy to interpret readings of relative weight. The 0% point can be set to a higher value than the 100% point if pour down or similar applications dictate.

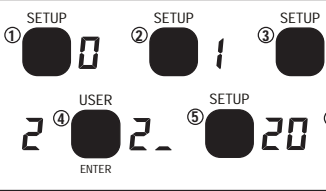
Turn on the Bargraph (PER CENT Operation Example)

<p>1. Press SETUP followed immediately by the ZERO key.</p>	
<p>2. Enable the Bargraph in the "BAR MODE" menu. Press ENTER.</p>	
<p>3. Press the UP key until the message reads "PER CENT". How many times you push the UP key is dependent on the last mode set). Press ENTER.</p>	
<p>4. Scroll to the "BAR 0%" menu. Press ENTER.</p>	
<p>5. Using the UP and DOWN keys enter the value that you want to equal 0% on the bargraph. In this example we will enter 10 as 0%.</p>	
<p>6. The next menu choice is "BAR 100%". Press ENTER.</p>	
<p>7. Using the UP and DOWN keys enter the value that you want to equal 100% on the bargraph. In this example we will enter 20 as 100%.</p>	
<p>8. Press the EXIT key to return to normal scale operation.</p>	

The bargraph is now activated. The 0% segment is equal to 10 lbs, the 100% segment is equal to 20 lbs.

SET POINTS MENU (SETUP-TEST)



The 3650 comes standard with 8 Software Set points. All the set points put a message on the display or blink or blank the display. Set points 1 and 2 have front panel LED indication. Add the Set points option for relay outputs. The option includes 7 - 115 VAC relays and an 8th logic output.

Top Menu	Sub-Menu	Selections
SP MODE		NORMAL , GRADING, BARSETPT, DISABLED
SET PT 1	MODE	GROSS , NETGROSS, TOTAL, DISABLE
	RESPONSE	NORMAL , MESSAGE, BLANK LCD, BLINK LCD (and backlight)
	VALUE	<, >, then Value
	HYSTERES	enter value up to 225 divisions
SET PT 2-8	(as above)	
TEST SP	(Relay option only)	OFF, SET PT 1, SET PT 2, SET PT 3, SET PT 4, SET PT 5, SET PT 6, SET PT 7, SET PT 8

SET PTn

The standard 3650 is equipped with 8 set points. These set points can be used to provide warnings and indications of weighing events. When the weight is above (greater than) or below (less than) a set value the 3650 can respond in a variety of ways. The normal response of the SET PT is to turn on a front panel LED (set point 1 and 2 only). Other SET PT responses possible are to send a message, blank the display, or blink the reading. In addition, the 3650 can be fitted with an expansion board which provides relay outputs and external opto-isolated outputs than can be used in batching and filling operations as well as safety related alarms.

SP MODE

The SP MODE (Set point Mode) menu selection provide a general enable/disable of Set points. In addition, the Set points can be configured in a “GRADING” mode, where each set point represents a grade threshold.

Set Point Mode Procedure:

- 1) Push SETUP followed immediately by the TEST key. You are now in the SETPOINTS menu.
- 2) Use the UP key or DOWN key to select the “SP MODE” menu selection. Push ENTER.

- 3) Use the UP/DOWN keys to select the Set Point mode desired; NORMAL, DISABLED, or GRADING.
- 4) Push ENTER.

SET PTn

Without the option board, the set points are functional only from the front panel with LED annunciators (SP1-2) or messages (SP1-8). The MSI 3650 relay option board adds up to 7 set point relay outputs and 1 external non-isolated logic output. These set points provide warnings and indications of weighing events. When the weight is above (greater than) or below (less than) a set value the 3650 can respond in a variety of ways. The normal response of the SET PT is to turn on a relay. Other SET PT responses possible are to blank or blink the display or send a message. These outputs are useful in batching and filling operations as well as safety related alarms.

Set Point Entry Procedure

Note : In order for set points to function they must be enabled. (See “Set Point Mode Procedure”).

- 1) Push SETUP followed immediately by the TEST key. You are now in the SETPOINTS menu.
- 2) Use the UP key or DOWN key to select the Set Point you wish to program. We will use Set Point 1 for this example.
- 3) When the display reads “SET PNT1” push ENTER .
- 4) The display will step to "MODE". Push ENTER . The first selection is "DISABLED". This mode allows the user to program a set point without the set point actually operating. To enable the set point, push the UP or DOWN key to select either the GROSS " mode or the NETGROSS mode. In the "GROSS" mode the set point will operate at the value set based on Gross Weight regardless of any tare value. If this is the desired set point operation mode push ENTER . If the set point should operate relative to a tared weight , use the "NET/GROSS" mode. In this mode the set point will operate at the value which represents either a Gross weight or a Net weight. Set points can also be programmed to correspond to a Totalled Weight. Use the “TOTAL” selection. In the “TOTAL” mode you can enter a set point value greater than capacity.
- 5) The next selection is the Set point "RESPONSE"...what should the scale do when the set point value is reached? Push ENTER . There are three selections: The "NORMAL" response turns on the internal relays (SP1-7) only. Use the UP/DOWN keys to change the response to "BLANK LCD". In this mode the LCD weight reading blanks out and the message displays SET PNT1. The relays functions as before. Use the key again to

change to the "BLINK LCD" response. Weight readings continue, but the display blinks. The "MESSAGE" response causes the message display to read "SET PNTx" where x is the Set Point that is in effect. In all three modes, the overload condition will override the display mode. After selecting the desired Set Point response, push ENTER .

- 6) The message display reads "VALUE". Push ENTER.
- 7) Select if the set point will be active when the weight is above (GREATER) or below (LESSTHAN) the entered value. Use the UP or DOWN key to select the mode. For overload alarms you would use "GREATER". When "GREATER" appears, push ENTER.
- 8) Push the UP or DOWN keys to enter the first digit of the desired Set Point weight value (value cannot exceed the capacity). Push ENTER.

Note : Use the POWER key to enter a decimal point.

- 9) The next significant digit flashes. Push the UP or DOWN keys to enter the next digit. Push ENTER. Push ENTER. To finish out the Set Point value entry, push ENTER on a blank character.
- 10) The next selection is the Set Point "HYSTERES" (hysteresis)...which allows a "dead zone" to be applied to the set point. This dead zone prevents "chatter" as the weight value passes the threshold. If, for example, a 10 pound set point with a 2 division hysteresis, and each division equal to .05 lbs, the set point will trigger at 10 lbs but will not trigger off until 9.9 lbs. To set hysteresis push ENTER at the "HYSTERES" message, and using the UP/DOWN keys enter the amount of desired hysteresis in display divisions. Push ENTER when finished.
- 11) The Set Point Menu is now back on the screen. Use the UP or DOWN key to return to any of the above operations (VALUE, MODE, RESPONSE, HYSTERES) if modifications need to be made. When finished programming the Set Point, push the EXIT key. Use the UP or DOWN key to select another Set Point or push EXIT again to quit and return to normal scale operation.

Use the same procedure for additional set points.

Disable a Set Point

It is often useful to be able to set up a Set Point ahead of time and disable it for testing purposes.

- 1) Push SETUP followed immediately by the TEST key. You are now in the SETPOINTS menu.
- 2) Use the UP key or DOWN key to select the Set Point you wish to disable. We will use Set Point 1 for this example.
- 3) When the display reads "SET PNT1" push ENTER .
- 4) Push until the "MODE" message appears. Push ENTER .

- 5) Push the UP or DOWN key until the message "DISABLED" appears. Push ENTER . This disables the set point and returns you to the Set Point Menu.
- 6) Push EXIT two more times to get out of the Set Point Menus and return to normal scale operation.
To re-enable the Set Point, follow steps 1-3 above. On step 4 select the "GROSS" mode or the "NET/GROSS" mode.

Disable all Set Points

- 1) Push SETUP followed immediately by the TEST key. You are now in the SETPOINTS menu.
- 2) Use the UP key to change the message to "DISABLED". Push ENTER.
- 3) Push EXIT to get out of the Set Point Menus and return to normal scale operation.

Using the MSI 3650 as a Grading Scale

The MSI-3650, with or without the Set Points relay option, can be set up as a multiple zone (up to 9) grading scale. The relay outputs can be connected to grading lights, or to automatic bins. In this example the 3650 will be used to grade in three zones, with additional over and under zones for a total of 5. In this example our grading zones are: <10 lbs, 10 to 10.5 lbs, 10.5 to 11 lbs, 11 to 11.5 lbs and >11.5 lbs. Also, by selecting the optional "MESSAGE" response, the display gives an indication of the Grade, removing the need for any additional hardware.

- 1) Push SETUP followed immediately by the TEST key. You are now in the SETPOINTS menu.
- 2) Use the UP key or DOWN key to select the "SP MODE" menu selection. Push ENTER.
- 3) Use the UP/DOWN keys to select "GRADING". Push ENTER.
- 4) Use the UP/DOWN keys to go to "SET PT 1". Push ENTER.
- 5) Using the Set Point Entry procedure above set up Set Point 1 as follows:
MODE = GROSS, RESPONSE = MESSAGE, VALUE = 10,
HYSTERES = 0.
- 6) Set Set Point 2 as follows: MODE = GROSS, RESPONSE = MESSAGE,
VALUE = 10, HYSTERES = 0.
- 7) Set Set Point 3 as follows: MODE = GROSS, RESPONSE = MESSAGE,
VALUE = 10.5, HYSTERES = 0.
- 8) Set Set Point 4 as follows: MODE = GROSS, RESPONSE = MESSAGE,
VALUE = 11, HYSTERES = 0.
- 9) Set Set Point 5 as follows: MODE = GROSS, RESPONSE = MESSAGE,
VALUE = 11.5, HYSTERES = 0.
- 10) Return to normal scale operation by pushing EXIT after entering the last Set Point (5).

Note: When GRADING mode is selected, the “VALUE” entry skips the “GREATER” and “LESSTHAN” entries. If the set points values were entered prior to enabling the “GRADING” mode the “GREATER” and “LESSTHAN” selections will be ignored.

CALIBRATION

The following sections are intended for qualified scale technicians.

It is not necessary to remove the meter front panel to calibrate. Only the small seal port screw on the left side of the unit should be removed!

General Information

For a standard Calibration do the following:

- 1) Enable Calibration
- 2) Select the “STD CAL” mode.
- 3) Follow the procedure in the “STANDARD CALIBRATION” section.

For an Initial Calibration and setting the Capacity or Count-by (d):

- 1) Do a Reset Calibration
- 2) Set the Units you wish to calibrate in with the UNITS menu. If pounds is the desired unit for calibration, you can skip this step. Use the Up/Down keys to scroll to the “UNITS” menu, select and ENTER the basic unit for the scale.
- 3) Follow the “INITIAL CALIBRATION” procedure to set capacity and gain.
- 4) If the unit is legal for trade, set the appropriate standard with the “LEGAL STANDARD” procedure. If the unit is to be used with metric units only set the standard to “METRIC”.
- 5) Reseal the Cal port when finished.

ENABLE CALIBRATION (FRONT PANEL)

Function:

An accurate test weight system of adequate capacity is required to calibrate an MSI-3650. Calibrate a Legal-for-Trade 3650 with a test weight set certified by the appropriate regulatory agency.

Operation

Enable Calibration:

Remove the seal screw on the left side of the 3650 Meter. Insert a small nonmetallic screwdriver or wooden “Q-Tip” and press the switch button in the hole.

Note: The 3650 must be in Powered On condition, not Clock/Calender Mode.

The Calibrate Setup Menu appears (display reads “CALSETUP” for 2 seconds). Push the UP or DOWN key to the desired operation as described below. Then push ENTER. On completion of calibration, return to normal operation by pushing the EXIT key.

CALIBRATE SETUP MENU

Note: The Setup section of the manual details the operation of these additional menu selections.

Top Menu	Selections
STD CAL	Starts the calibration
UNITS	lbs, kg, oz, g, daN, tons, metric tons
FINE CAL	Allows minor trimming of calibration
STANDARD	INDUSTRY, NIST, OIML, METRIC
AZM	ENABLE, DISABLE

SELECT LEGAL STANDARD

The STANDARD function allows the 3650 to be configured as required by various regulatory agencies. The “INDUSTRY” selection is the default. Choose “NIST” for US and Canadian Legal-for-Trade units. Choose “OIML” for European LFT applications. “METRIC” is the same as “INDUSTRY” except only kg and g units are enabled.

- 1) If you are not already in the Setup Cal Menu, enable Calibration by removing the seal screw on the left side of the 3650. Insert a small nonmetallic screwdriver or wooden “Q-Tip” and press the switch button in the hole. Once the switch is pushed, the display will read “CALSETUP” for 2 seconds.
- 2) Use the UP or DOWN key to scroll to the "STANDARD" message. Press ENTER.
- 3) Use the UP or DOWN key to scroll through the Standards options. When the display indicates the desired configuration, push ENTER .

Note: Contact the factory for details on the differences between the various configurations.

SELECT CALIBRATION UNITS

Calibration units determine the base default units the scale is calibrated in. The capacity initially programmed in the calibration units determines the overload value.

- 1) If you are not already in the Setup Cal Menu, enable Calibration by removing the seal screw on the left side of the 3650 Meter. Insert a small nonmetallic screwdriver or wooden “Q-Tip” and press the switch button in the hole. Once the switch is pushed, the display will read “CALSETUP” for 2 seconds.
- 2) Use the UP or DOWN key to scroll to the "UNITS" message. Press ENTER .
- 3) Use the UP or DOWN key to scroll through the Units options. When the display indicates the desired units, push ENTER .

Note: If lbs-oz is the preferred measurement mode, calibrate the scale in pounds.

CALIBRATE (STANDARD CALIBRATION)

Note: Use this Calibration procedure for normal test weight calibration of the 3650. If capacity or gain changes are necessary (such as an initial setup of a system) go to the Initial Calibration Procedure.

- 1) If you are not already in the Setup Cal Menu, enable Calibration by removing the seal screw on the left side of the 3650 Meter. Insert a small nonmetallic screwdriver or wooden “Q-Tip” and press the switch button in the hole. Once the switch is pushed, the display will read “CALSETUP” for 2 seconds.
- 2) Use the UP or DOWN key to scroll to the "STD CAL" message. Push ENTER.
- 3) The message reads “Ø SCALE”. Remove all weight from the scale. When motion ceases push ZERO or ENTER. The display reads “CAL’ ING”. Wait for about 5 seconds. Assuming the detected zero weight is within acceptable limits the message reads “WEIGHT” indicating it is time to apply the test weight(s).
- 4) Load the Scale with at least 20% of capacity. A test weight of 50% or more of capacity is recommended for highest accuracy.
- 5) If you are loading the scale with exact, full capacity push the ENTER key and go on to step 7. If loading the scale with anything other than full capacity, go to step 6.

- 6) Enter the first digit of the calibration weight by using the UP or DOWN keys. When a match is made push ENTER. Use the POWER key to enter a decimal point if needed. Repeat for the remaining digits. Finalize the calibration weight entry by pushing ENTER on a blank character. If the span constant is within acceptable limits the message display reads “CAL OK” briefly.

Calibration Example: 5 lbs of dead weights are available to calibrate a 2.5 kg scale. Since $5.000 \text{ lbs} = 2.268 \text{ kgs} (5 * 0.4536)$, the number entered with the UP/DOWN and ENTER keys would be 2.268. The 3650 calculates the span factor needed.

- 7) RCAL CALCULATION – The display reads “UNLOAD”. Remove any weight on the platter and push ENTER. The LCD shows “----” while calculating the RCAL value (~5 seconds). The RCAL value is displayed for 5 seconds. Make a note of the value for future reference.

Note: If an RCAL value is not needed, push EXIT when the display reads “UNLOAD”.

- 8) The display indicates “STORING” while all the calibration constants are stored in permanent memory.
- 9) Calibration is complete, push EXIT to return to normal scale operation, or push UP/DOWN to choose another Calibrate Setup function. Seal the calibration port.

Note: On systems such as hoppers or tanks where it is impossible to unload the scale, the RCAL will probably return a error message. The unit will still function fine, but RCAL will not function.

Calibration Error Messages

–ZERO ERR: This error indicates that there is too much negative offset in the load cell. This can be corrected by changing the gain, adding dead load, or by adding offset resistor RA. Adding RA located on the PCB near the load cell connector this offset can usually be reduced enough for normal scale operation. Contact the factory for details on selecting the value of RA.

CAL ERR: The “CAL ERR” message indicates there was either insufficient or too much weight on the scale for proper calibration to the set capacity. Pushing ENTER will return you to the ZERO step (step 2) so you can try again with the proper weight. Pushing EXIT will restore the previous calibration constants and return you to the Calibration Setup Menu.

RCAL ERR: If the calculated RCAL is less than 10% of scale, or if the measurement overloads the A/D converter, this message will occur. It

does not mean the scale is unusable, only that RCAL was outside of range. Will definitely occur if the scale has significant load present.

UNDERRNG: In the calibrate menus, an under-range indication means that the A/D is out of zero range. This can be caused by a load cell with too much negative offset. Add deadload or use RA to bring the zero counts higher.

OVER RNG: In the calibrate menus, an Over-range indication means that the A/D has exceeded its maximum count. Can be caused by excessive positive offset, or by too much weight on the scale. Either reduce the load on the scale or use RB to lower the counts.

RESET CALIBRATION

Caution: DO NOT initiate this function unless you are prepared and qualified to perform a complete initialization and Calibration procedure.

Function:

Completely clears the internal EEROM of calibration settings, including capacity and count-by (d). Usually used for board replacement, changing capacity and/or resolution, troubleshooting, or Load cell replacement.

Does not change any previously set Setup functions.

Operation:

To clear the calibration constants, push the CALIBRATION (inside the seal port) key and then push the CLEAR (UNITS) key (the two keys must be pushed in sequence within 3 seconds). The message will display "RESETCAL". A full calibration must follow this operation.

RESET ALL

Caution: DO NOT initiate this function unless you are prepared and qualified to perform a complete initialization and Calibration procedure.

Function:

Similar to the RESETCAL plus all setup functions are returned to defaults. Starts the scale from scratch. Usually used for board replacement, changing capacity and/or resolution, troubleshooting, or load cell replacement.

Operation:

To cause a system initialization, push the CALIBRATION (inside the seal port) key, then push the CLEAR (UNITS) key, then push the ZERO key (all three keys must be pushed in sequence, not at the same time, within 3 seconds). The message will display "RESETALL". A full calibration must follow this operation.

INITIAL CALIBRATION (PERFORMED ONLY AFTER A RESET CALIBRATION)

Note: The following procedure is for use only when changing the load cell, the electronics package, or when changing the capacity or count-by (d) of the scale. Use the “STANDARD CALIBRATION” procedure for routine calibration of the 3650.

- 1) Insert a small nonmetallic screwdriver or wooden “Q-Tip” into the calibration seal port. Push the CALIBRATION key (inside the seal port) followed quickly by the CLEAR (UNITS) key (the two keys must be pushed in sequence within 3 seconds). The message will display “RESETCAL”. **NOTE:** Do Not push the two keys at the same time.
- 2) If pounds are the units for calibration go on to step 3. If not, scroll to the “UNITS” menu choice. Push ENTER. Use the UP key to scroll through the units choices. Push ENTER when the proper unit matching your calibration weights is displayed.
- 3) Use the UP or DOWN key to scroll to the “STD CAL” message. Press ENTER.
- 4) First, the power input mode must be selected. The “PWR BATT” message is displayed. If the unit is powered by the MSI Battery Option push ENTER. If the unit is powered by AC, push the UP key until the display reads “PWR AC”, then push ENTER. If the unit is powered by the MSI 12-56 V adaptor, push the UP key until the display reads “PWR VEH”, then push ENTER.
- 5) First set the capacity of the system. Capacity is usually set to the capacity of the load cell. Display reads “CAPACITY”. Push the UP or DOWN key until the display indicates the first digit of the desired weight value. Push ENTER.

Note: Capacities range up to 999,999 calibration units in any units. If “lbs-oz” is the desired measurement mode, enter the capacity in pounds and/or fractional pounds.

- 6) The next most significant digit flashes. Use the UP, DOWN and ENTER keys to finish out the capacity entry. Use the POWER key to input a decimal point if needed. Push ENTER on a blank character to finalize the capacity value.

Note: During capacity entry, you can backstep delete any incorrect entry using the CLEAR (TEST) key.

- 7) Next, enter the resolution in scale divisions (d). The 3650 defaults to 3000 counts or less resolution. The message display reads “COUNT

BY”. The numeric display indicates the calculated “d” value. Use the UP key to decrease resolution (increase the count-by). Use the DOWN key to increase resolution (decrease the count-by). Increments are in a 1-2-5 sequence.

Note: MSI does not recommend increasing the resolution beyond 12500 counts. You can determine resolution by dividing the capacity by the count by. For example, a 250 kg capacity scale with a count by of 0.02 kg would have 12500 counts (250/.02). Going beyond 12500 counts can cause noisy readings. Most platform Load Cells are best suited for resolutions of 5000 counts or lower.

- 8) Next, the MSI-3650 prompts you to enter the “GAIN”. Use the UP or DOWN key to select the range which matches the mV/V of your load cell. Ranges available are:

Load Cell Output Range	Gain
<.6mV/V	8
.6 to .84	7
.85 to 1.19	6
1.2 to 1.69	5
1.7 to 2.39	4
2.4 to 3.39	3
3.4 to 4.79	2
4.8 to 7.0	1

The Bargraph can be used to aid in picking the proper gain. Load the scale to capacity. Increase the gain until the farthest right segment is illuminated, then back down one gain setting. The Accept is equal to half scale. Each under segment equals 5% of span below half scale. Each over segment equals 5% of span above half scale. The display will indicate “OVER RNG” or “UNDERRNG” if the A/D is out of limits. A persistent under-range possibly indicates the need to add resistor RA to bring up the output at zero. A zero setting on the bargraph that is too high can be brought down by adding resistor RB. Typical values for RA or RB are 150kΩ 5 to 25PPM MF for 350Ω load cells or 499kΩ 5 to 25PPM MF for 2000Ω load cells.

- 9) Once the proper gain setting is selected, push ENTER. The gain setting must be made properly to ensure that there is an adequate number of A/D counts. Too low a setting can result in linearity or noise problems. Too high a setting will cause the A/D to over-range prematurely.
- 10) The message reads “Ø SCALE”. Remove all weight from the scale. When motion ceases push ZERO (or ENTER). The display reads “CAL’ING”. Wait for about 5 seconds. Assuming the detected zero

weight is within acceptable limits the message reads "WEIGHT" indicating it is time to apply the test weight(s).

- 11) Load the Scale with at least 20% of capacity. A test weight of 50% or more of capacity is recommended for highest accuracy.
- 12) If you are loading the scale with exact, full capacity push the ENTER key and go on to step 14. If loading the scale with anything other than full capacity, go to step 13.
- 13) Enter the first digit of the calibration weight by using the UP or DOWN keys. When a match is made push ENTER . Use the POWER key to enter a decimal point if needed. Repeat for the remaining digits. Finalize the calibration weight entry by pushing ENTER on a blank character. If the span constant is within acceptable limits the message display reads "CAL OK" briefly.

Calibration Example: 50 lbs of dead weights are available to calibrate a 25 kg scale. Since $50.00 \text{ lbs} = 22.68 \text{ kgs}$ (50×0.4536), the number entered with the UP/DOWN and ENTER keys would be 22.68. The 3650 calculates the span factor needed.

- 14) Next the 3650 prompts you to "UNLOAD" the scale. Remove any weight on the platter and push ENTER. Wait 5 to 20 seconds. The LCD shows "--" while calculating.
- 15) RCAL CALCULATION – The display reads "UNLOAD". Remove any weight on the platter and push ENTER. The LCD shows "----" while calculating the RCAL value (~5 seconds). The RCAL value is displayed for 5 seconds. Make a note of the value for future reference. NOTE: If an RCAL value is not needed, push EXIT when the display reads "UNLOAD".
- 16) The display indicates "STORING" while all the calibration constants are stored in permanent memory.
- 17) Calibration is complete, push EXIT to return to normal scale operation, or push UP/DOWN to choose another Calibrate Setup function.

FINE CALIBRATE

Fine calibration is for minor adjustments to the calibration and is usually not necessary.

- 1) If you are not already in the Setup Cal Menu, enable Calibration by removing the seal screw on the left side of the 3650 Meter. Insert a small nonmetallic screwdriver or wooden "Q-Tip" and press the switch button in the hole. Once the switch is pushed, the display will read "CALSETUP" for 2 seconds.
- 2) Use the UP/DOWN key to scroll to the "FINE CAL" message. Push ENTER.

- 3) Place a test weight of at least 25% of capacity on the scale. The weight is indicated on the numeric digits. **WARNING:** This function will not work unless the scale is loaded at 25% of capacity or more. The numeric digits won't display weight until the scale is loaded to 25% or more.
- 4) Use the UP key to cause the displayed reading to move up slightly. Each key press is approximately 1/4 display count. It might take up to 4 pushes for a single digit change. Use the DOWN key to cause the reading to move down. When the displayed reading is acceptable push ENTER.
- 5) Fine Calibration is complete, push EXIT to return to normal scale operation, or push UP/DOWN to choose another Calibrate Setup function.

ENABLE/DISABLE AZM (AUTO ZERO MAINTENANCE)

- 1) If you are not already in the Setup Cal Menu, enable Calibration by removing the seal screw on the left side of the 3650 Meter. Insert a small nonmetallic screwdriver or wooden "Q-Tip" and press the switch button in the hole. Once the switch is pushed, the display will read "CALSETUP" for 2 seconds.
- 2) Use the UP/DOWN keys to scroll to the "AZM" message. Push ENTER .
- 3) Use the UP/DOWN keys to scroll through the AZM options. After scrolling to the desired mode (ENABLED, or DISABLED) push ENTER .

Caution: Disabling Auto Zero Maintenance will degrade temperature and drift performance of the MSI-3650. Disable AZM only for meter testing purposes. A power-on start-up message will say "AZM OFF" until Auto Zero Maintenance is re-enabled.

CALIBRATION MENU MAP

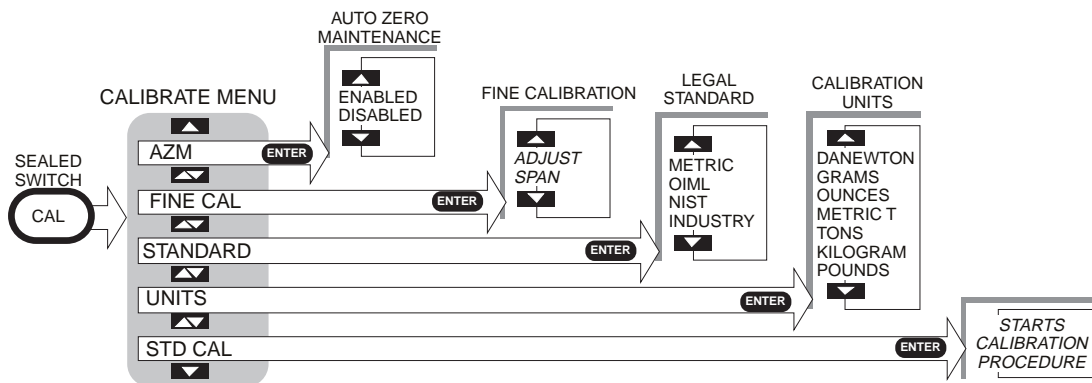

CALIBRATION FLOW CHART

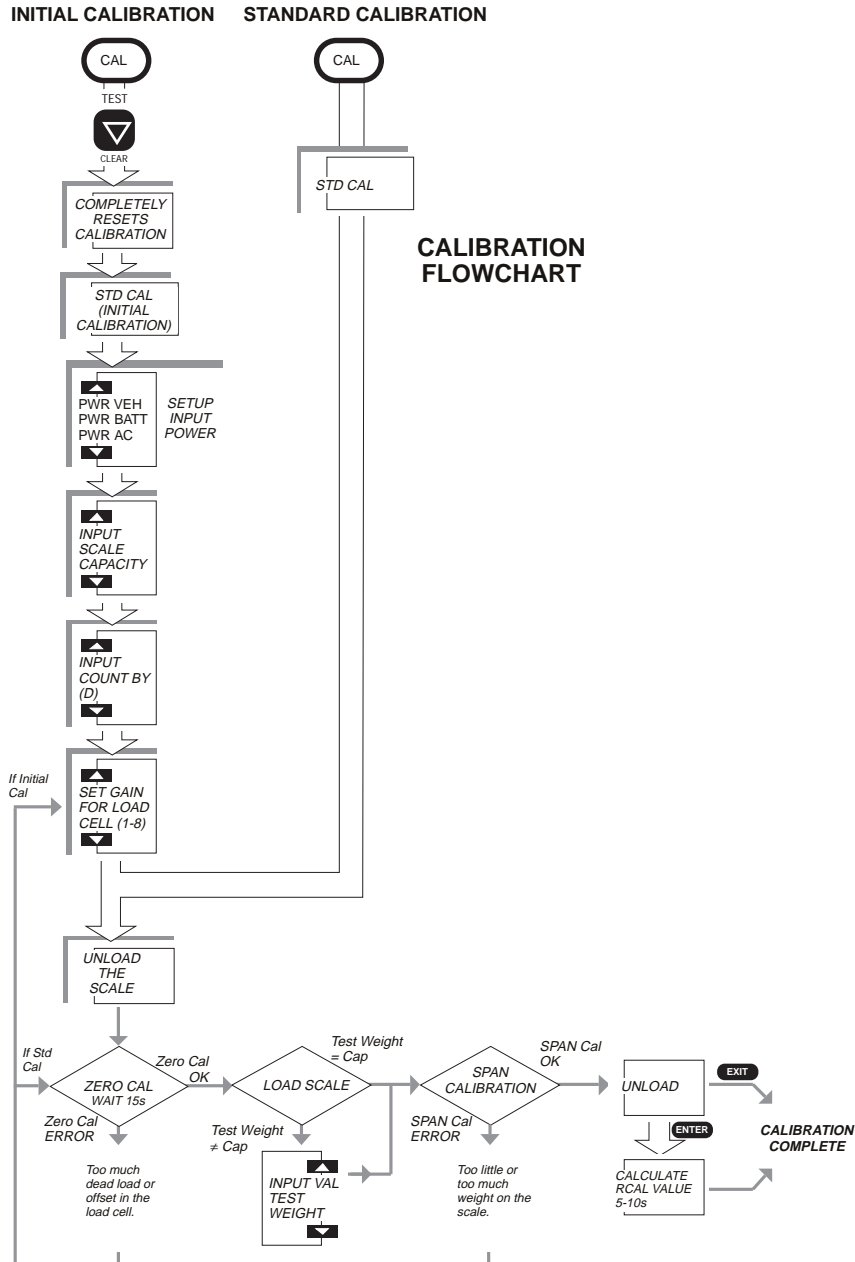

SPECIFICATIONS

Accuracy:	HB-44 Class III/IIIL
Maximum Resolution:	12,500 displayed counts / 65,000 counts internal
Standard Industrial Resolution:	Up to 10000 displayed counts, Class III or Class IIIL
Load Cells:	Will drive up to 8 350 Ω cells. Will drive up to 16 2000 Ω cells. (Contact MSI for information on 2000 Ω gaged Load Cells)
Sensitivity:	.3 microvolt per displayed digit minimum. Suitable for load cells from .6mV/V to 7mV/V. Higher output cells can be attenuated with a junction box.
Drift:	Zero: Less than 5PPM/ °C Span: Less than 15PPM/ °C
Capacity:	Any capacity can be specified up to 999,999 units (lbs, kgs, tons, etc.)
Over Capacity:	Indicates “ERROR OVERLOAD” when the set capacity is exceeded by 8 “d”.
Increments (d):	Setable to multiples or submultiples of X1, X2, X5 down to X0.0001
Display:	<ul style="list-style-type: none">• 6 digit .9 inch (23 mm) high numeric LCD (weight display)• 8 digit 0.45 inch (11 mm) high alphanumeric LCD (message/units display)• 21 Segment Bargraph for process control % indications, also used for level indications on the MSI Lift truck Scale (LFT versions)• Annunciators for measurement modes• Sunlight visible LED indicator for Totalization, Set points 1 and 2• Photocell activated fiber-optic LED backlighting (Option)
Filtering:	6 pole digital filtering, Low, Medium, High (user selectable)
Power:	<ul style="list-style-type: none">• 90 to 250 VAC – 48 to 400 Hz, less than 3VA• Or battery operated with 2 standard “D” Cells• DC operated from 12 to 56 V
Battery Operating Time:	400 hours (2000 Ω gages) or 100 hours (350 Ω gages) typical with occasional use of the LCD backlight . Typically 100 hours (2000 Ω gages) with continuous use of backlight (on low setting).
Temperature Range:	<ul style="list-style-type: none">• -10° C to +40° C (+14° F to +104° F) NTEP certified range• -20° C to +60° C (-4° F to +140° F) Operating• -40° C to +80° C (-40° F to +176° F) Storage
Enclosure:	NEMA 4, Alodined and powder coated cast aluminum

Functions

Power: On/Off

Zero: Zero out residual weight on scale platter

Net/Gross:

Switch between Tared (Net) and Gross weight

Tare: Tare out empty container weight and read in the Net weighing mode

Total: Adds the current weight to a total register or turn on Auto-Total

View Σ : Displays accumulated weight for the current ID#

Print: Digital output of current weight to external devices

User: For programming user defined functions

Test: Display and Function Test, also provides battery condition in % (percent)

Setup: For selection of user programming functions

Programmable Features

- Automatic or Manual Tare Entry
- 8 Set points Standard with display annunciation, add option for relay outputs
- 8 zone Grading Scale Capability
- Peak Hold for capturing peak readings (User key option)
- Front Panel UNITs switching (User key option)
- Automatic or Manual Totalizing with weighments counter
- Up to 10 ID Codes. (50 optional)
- Each ID Code can have a name assigned for easy product identification
- Automatic Totalizing with Weighments Counter
- Each ID Code has independent Total Registers
- Automatic Power-Down, for power saving in battery applications
- Backlight On/Off/Automatic
- Lock: The programmer can lock any or all features to prevent tampering with setups, or to lock the scale into the basic, simple mode.
- USER key can be programmed by the end user for various functions
- RS232 Option will print on demand, on a change, regular interval (up to 8 hours), by reaching a set point, or by computer control

Calibration: Fully digital

Warranty: One Year

OPTIONS

- NTEP certification and OIML Legal-for-Trade approved (approvals pending). Contact factory for US and International specifications. Class III / IIIL
- RS232 and Real Time Clock: The RS232 option enhances the MSI-3650 by providing an interface for printers, scoreboards, or computers. Full print output formatting is provided allowing easy interface to any label or ticket printer. The Real Time Clock provides full time and date stamping of any and all printed data. The RT Clock provides scale throughput monitoring in combination with the Total functions. Use the RT Clock as a clock/calender when the scale is off.
- 2nd Isolated RS232/RS485: Isolated 2 way RS232 communications can interface the 6000 to a remote printer, scoreboard, or computer. Requires cable. RS485 output provided for networking or driving long cables (up to 4000' or 1300m)
- Set point Relay Option: Provides up to 8 set point outputs for interfacing to external devices such as warning lights, process relays, or sirens. 7 SPDT (form C) 1A/115VAC relays are provided internal to the 3650 meter for direct set-point interfacing. The 8th output is a TTL compatible Logic output. Connections are made through liquid tight feedthrough connectors to screw terminal blocks.
- Display Backlight: Photocell activated red backlit display for installations where the light level is too low to read the LCD. Red background color with black characters preserves night vision and reduces eye fatigue. Brightness of the Backlight can be controlled in three steps.
- Expanded ID Memory: Expands the ID memory from 10 ID codes to 50 ID codes. Each ID code has an 8 character name, and stores independently units, tare, zero, and total with weighments counter.
- Fiber Optics Output: Isolated fiber optics output with 1km transmit range.
- Audible Set points Indicator: Coupled with the internal set points, a single (pulsing) or dual level (pulsing or steady tone) overload alarm can sound at any weight. Can also be used for accept or an out-of-limits indicator for blind check-weighing.

- **Aux Digital Inputs:** Any key or all keys can be duplicated external to the meter.
- **Connector Option:** The 3650 can be supplied with military style connectors for Load Cell, RS232, and Power.
- **Mounting Bracket:** For wall or bulkhead mounting. 180° swing.

MSI-3650 MENU MAP

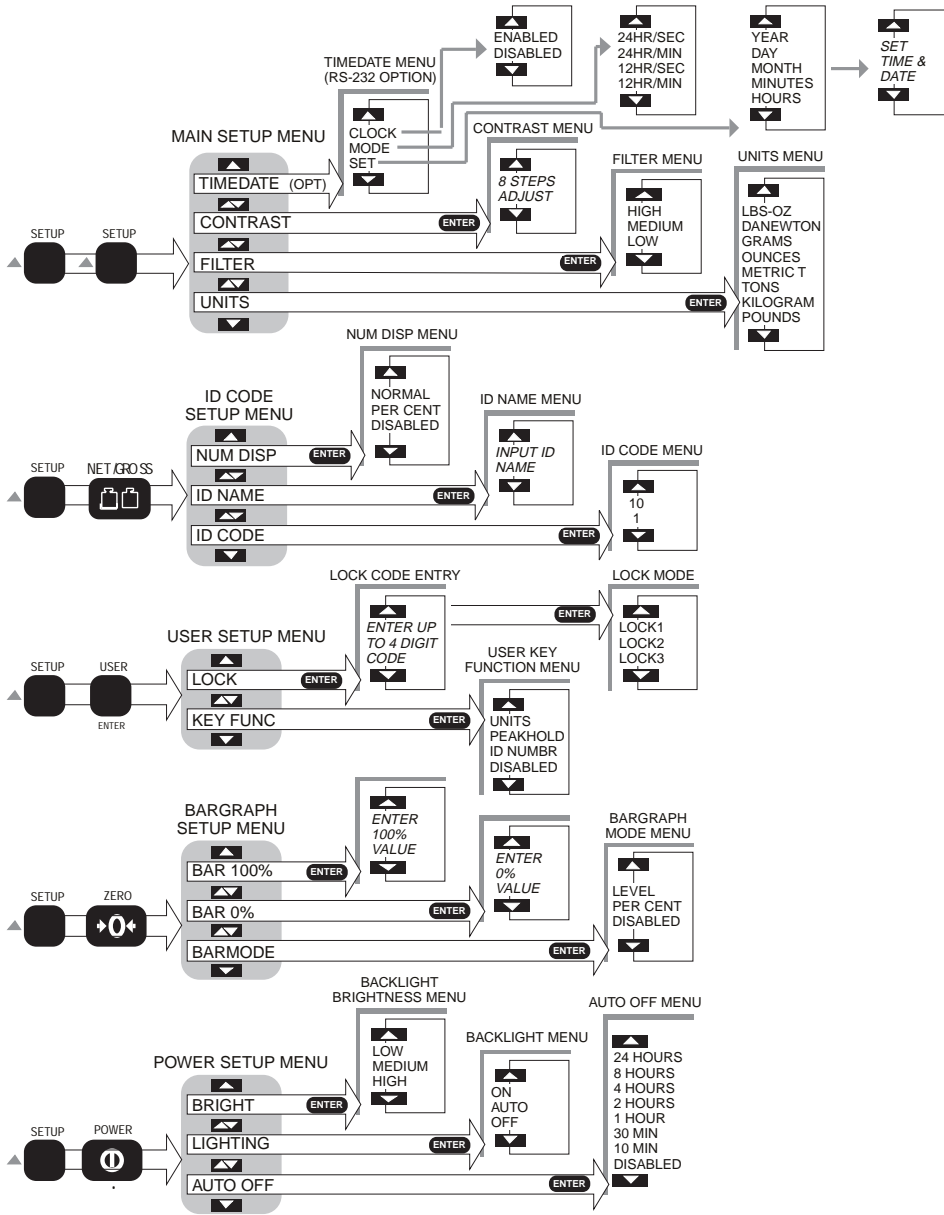

MOUNTING BRACKET ASSEMBLY

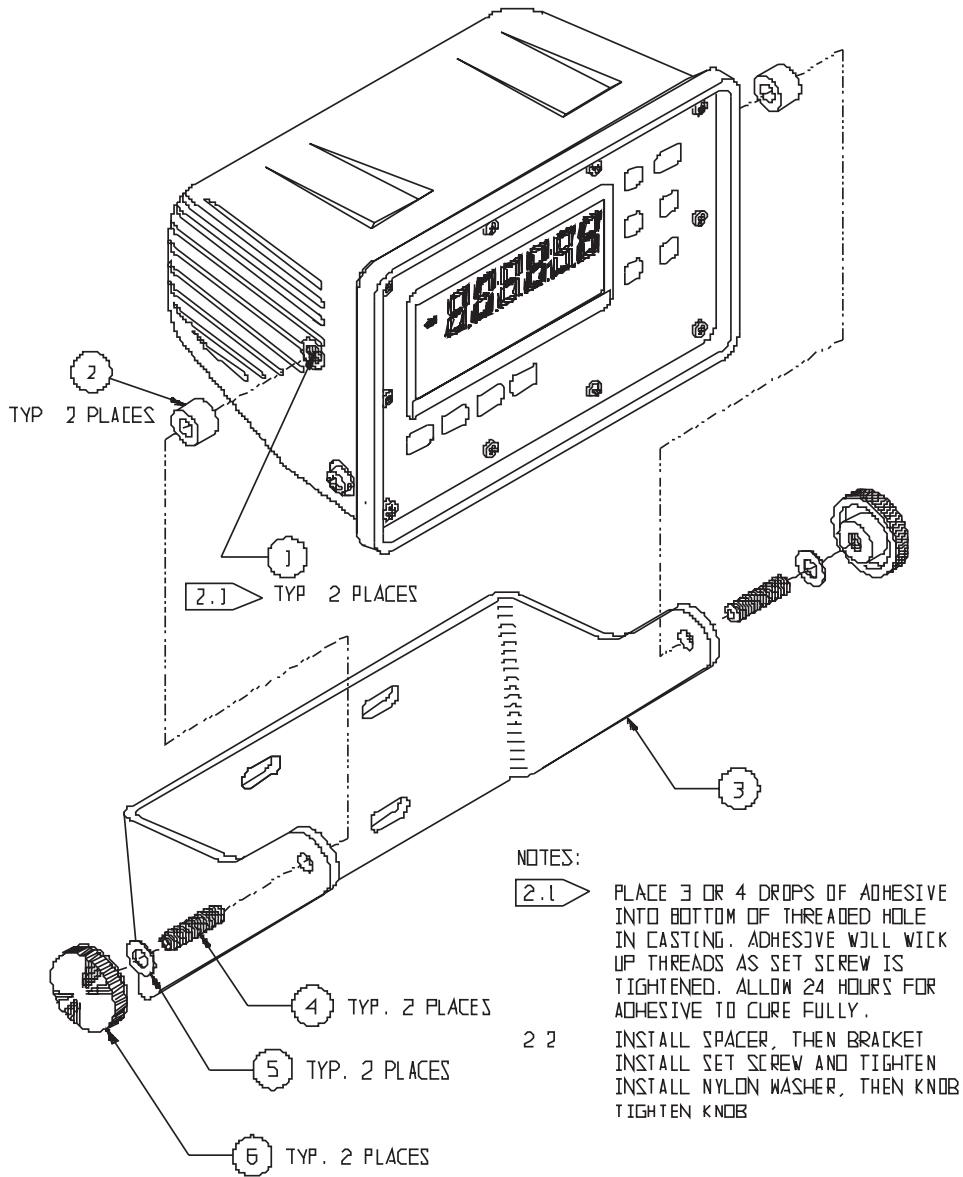

THE MSI LIMITED WARRANTY

MEASUREMENT SYSTEMS INTERNATIONAL, INC., warrants load sensing elements and meters against defects in workmanship and materials for a period of one year from date of purchase and warrants electrical cables and batteries against the same defects for a period of ninety (90) days from date of purchase.

Any device which proves defective during the warranty period will be replaced or repaired at no charge; provided that the defective device is returned to the Company freight prepaid.

In no event shall the Company be liable for the cost of any repairs or alterations made by others except those repairs or alterations made with its specific written consent, nor shall the Company be liable for any damages or delays whether caused by defective workmanship, materials or otherwise.

The Company shall not be liable for any personal injury or property damage resulting from the handling, possession or use of the equipment by the customer.

The warranty set forth herein is exclusive and is expressly in lieu of all other warranties, express or implied, including without limitation any implied warranties of merchantability or fitness, or of any other obligations or liability on the part of the Company.

The liability of the Company under this warranty is limited solely to repairing or replacing its products during the warranty periods; and the final judgement and disposition of all claims will be made by MEASUREMENT SYSTEMS INTERNATIONAL, INC.



©1999 by Measurement Systems International
Printed in U.S.A.
PUB.227-05-93B



Measurement Systems International

14240 INTERURBAN AVENUE SOUTH
SEATTLE, WASHINGTON 98168-4660 U.S.A.
206-433-0199 • FAX: 206-244-8470
WEB: www.msiscales.com • EMAIL: info@msiscales.com